

**vilma**

**ELECTRIC  
INSTALLATION  
PRODUCTS**

CATALOGUE 2020



# CONTENTS

---

About the company	2
QUADRUM QR 1000	14
EXPRESS XP 500	30
LUXE LX 200	59
SPECTRUM SP 300	76
STANDARD ST 150	91
STYLE SL 250	106
STYLE PLUS SL+250	117
Other products	121
Dimensions	128
Diagrams	132
Conventional symbols	136





AB VILMA is Lithuanian manufacturer of electrical installation products with a leading position in the Baltic States. Our company offers a wide range of electrical installation goods which meet requirements of European standards, top quality of production, and are long-lasting: switches, sockets, telephone and computer jacks, speaker jacks, etc. Exceptional design of the products will create an exclusive and cosy interior for your home.

Our electrical installation goods are produced by Swiss automated assembly equipment, thereby ensuring the highest quality products. The use of automated equipment allows only identical components to be selected and used for production, and their precise verification guarantees that the product will work reliably and for a long time.

VILMA products undergo constant improvements and are regularly checked by our company's quality specialists. The constant growth from year to year in demand for our products is the result of unmitigated customer confidence in our products. Currently our products are sold not only in Lithuania, but also in Latvia, Estonia, Russia, Belarus, Ukraine, Georgia, Norway and Spain.

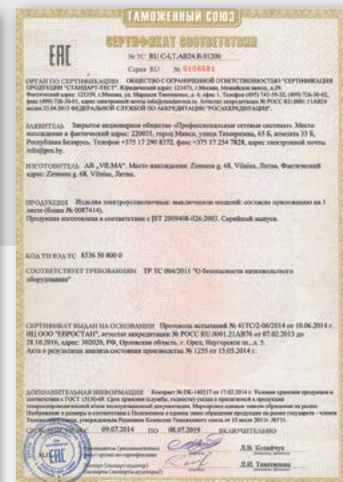
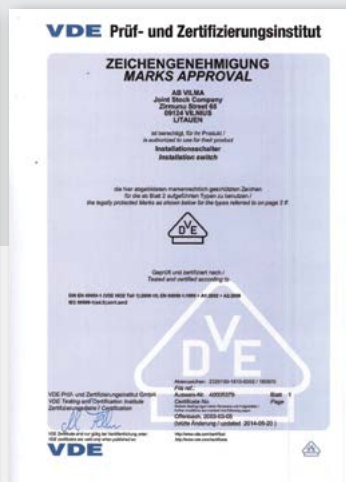

# USB

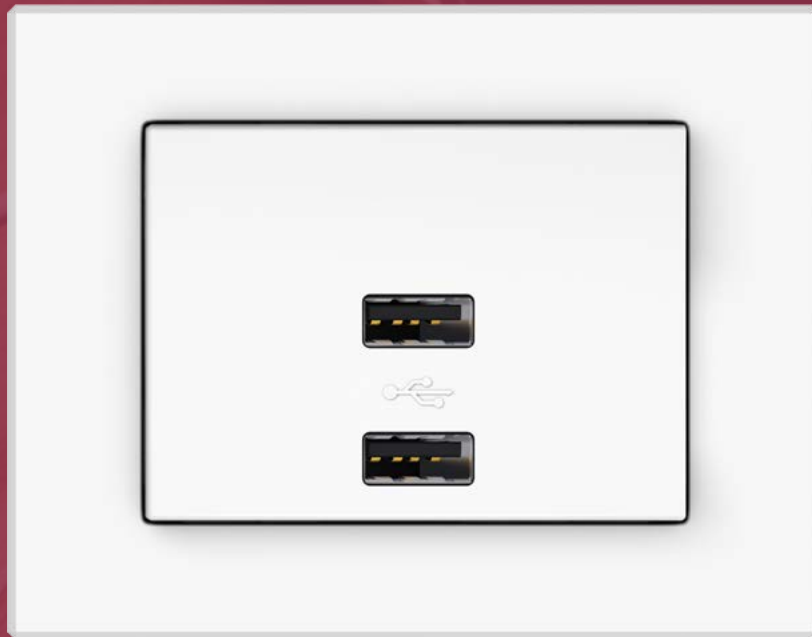

EXPRESS XP 500

---

## New – stationary USB outlets of series **EXPRESS XP500**

More and more smart devices, whose operation is constantly required, are making their appearance in modern life and charging convenience is an integral part of comfortable life. Stationary USB outlets have been created for this purpose – they not only make charging of devices easier, but also help to keep the interior stylish and integral.



# LIGHT CONTROL

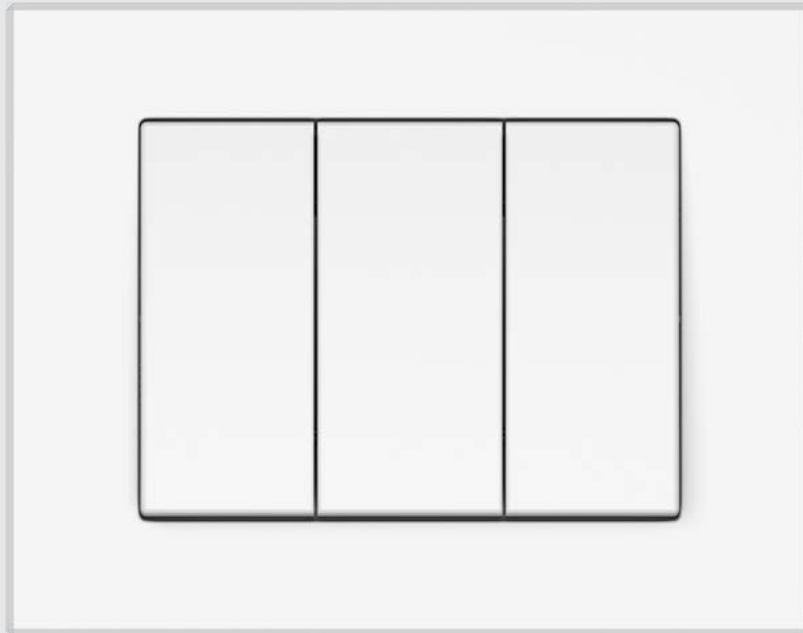

EXPRESS XP 500

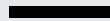

Switching lights on and off at home, work, or public spaces, is simply part of our everyday life. Consequently, we are well aware of switches with one, two or three buttons, which control of one, two or three light sources. Sometimes, however, we do not imagine that the daily management of the light can be made even more convenient and more customised to each individual requirement.

If you need to turn a light on and off frequently and from multiple locations, a relay switch might be the perfect solution for you. It is ideal for stairwells, corridors or other larger spaces where just one control point proves inconvenient. Sometimes we want to control lights from different locations. One example would be the bedroom, where you would prefer to turn off the light from your bed. The ideal solution here is a relay switch that lets you turn the light on or off both on entering the room and also from two separate places at the bedside.

# DIMMERS

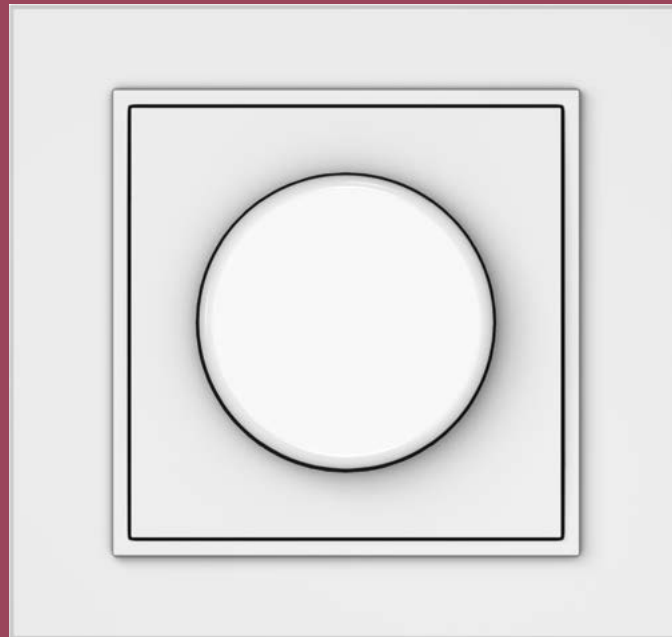

QUADRUN QR 1000

---

The intensity of light in the room depends not only on the time of day, but also on a person's mood or habits. The use of a dimmer lets you achieve the optimal solution for light control.

VILMA light dimmers work by pressing a round button, which can be turned for regulating the intensity of the light. For your convenience, when you turn off the dimmer then turn it on again, the light intensity remains at the last setting used. Our dimmer can also be used as an on/off switch. As diode light (LED) illumination becomes more popular, we recommend the use of VILMA LED dimmers, which enable you to regulate LED dimmable lightbulbs. You could also choose our standard dimmer, which is for use with heat lamps and halogen lamps. These products come in the series QUADRUN QR 1000, EXPRESS XP 500, LUXE LX 200, SPECTRUM SP 300 and STANDARD ST 150.





In order to create a safe and comfortable home environment, electrical installations must be closely in line with living conditions and needs. In certain home spaces such as bathrooms, due to the higher humidity in the room, there can be additional requirements for switches and sockets. VILMA IP44 protection class switches and sockets are additionally splash-resistant and can be installed in the right bathroom areas for you.

When choosing sockets, security is particularly important if there are children at home. Accidental contact with sockets can be prevented by having sockets with additional shutters, which open when the plug of an appliance is smoothly inserted into the slot.

# EVEN MORE SAFETY



STANDARD ST 150



STANDARD ST 150

# BLIND SWITCH

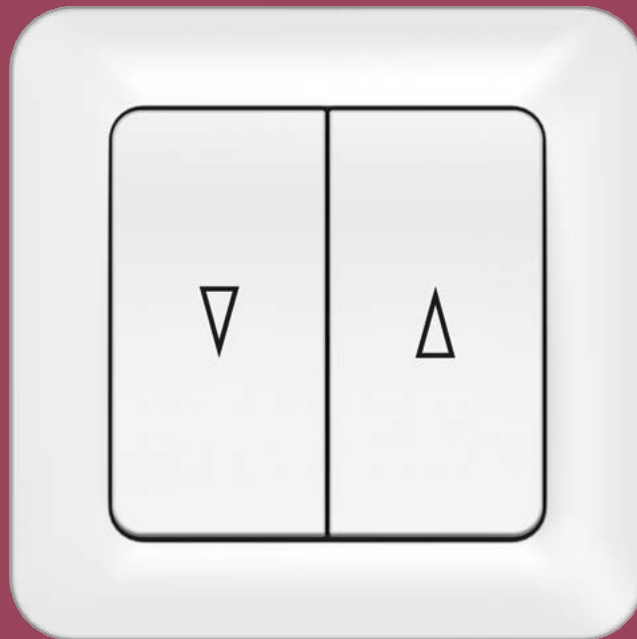

STYLE SL 250

---

As well as interior lighting, we offer you a comfortable and easy way to adjust the light entering from outside. With a VILMA blind switch you will be able to easily and comfortably manage both indoor and outdoor roller blinds or curtains, simply with the click of a button. In addition, it will be compatible with other VILMA switches operating in the house.

# ROOM AND FLOOR THERMOSTATS

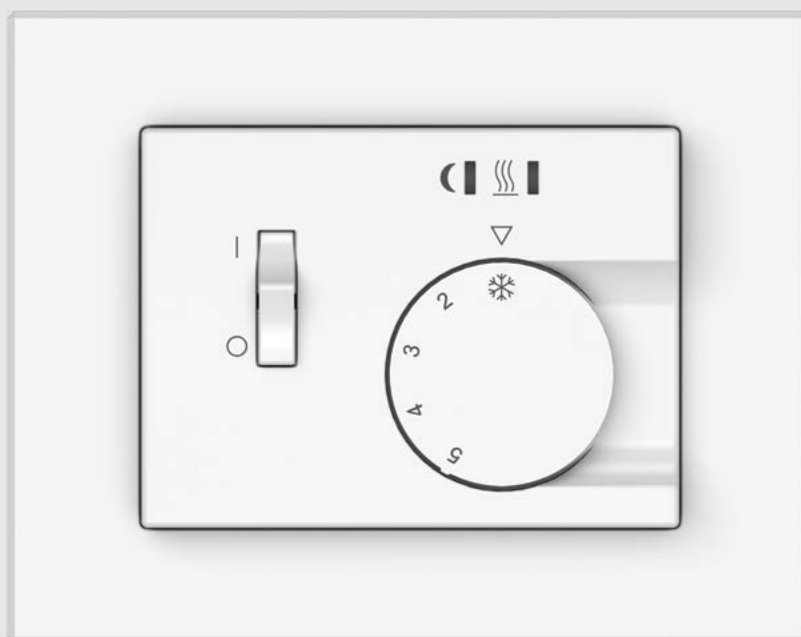

EXPRESS XP 500

Each of us likes the house to be warm and cosy, and with VILMA products, it's simple. The VILMA room thermostat with an internal temperature sensor allows you to conveniently and effectively manage home heating. The desired temperature is maintained, because the thermostat turns the house's thermal management devices on or off when the room temperature drops or exceeds the set threshold.

For those who want a device to adjust the electric floor heating, we recommend you choose the VILMA floor thermostat. With a gentle turn of a regulating dial, you set the desired floor temperature, which is maintained by an external sensor in the floor. Both the room thermostat and the floor thermostat can operate in economy mode, automatically lowering the temperature at night or at other times of the day, saving heating and electricity costs. Both thermostats are easy to turn on or off from the switch on top of them, and their mode of operation is always displayed with indicator lights. You can choose our thermostats from series EXPRESS XP 500 and LUXE LX 200.

# DATA TRANSFER



EXPRESS XP 500



EXPRESS XP 500

Modern technology makes our lives more comfortable and vibrant. Television, computers or home sound systems are an inseparable part of daily life. Therefore, when planning the layout of a house, the need for connection points for computers, television or speakers is a priority.

Particularly useful are places to plug in USB or HDMI connections, so that data storage or data transfer devices can be used in a spot that is convenient for you.



# QUADRUM QR 1000

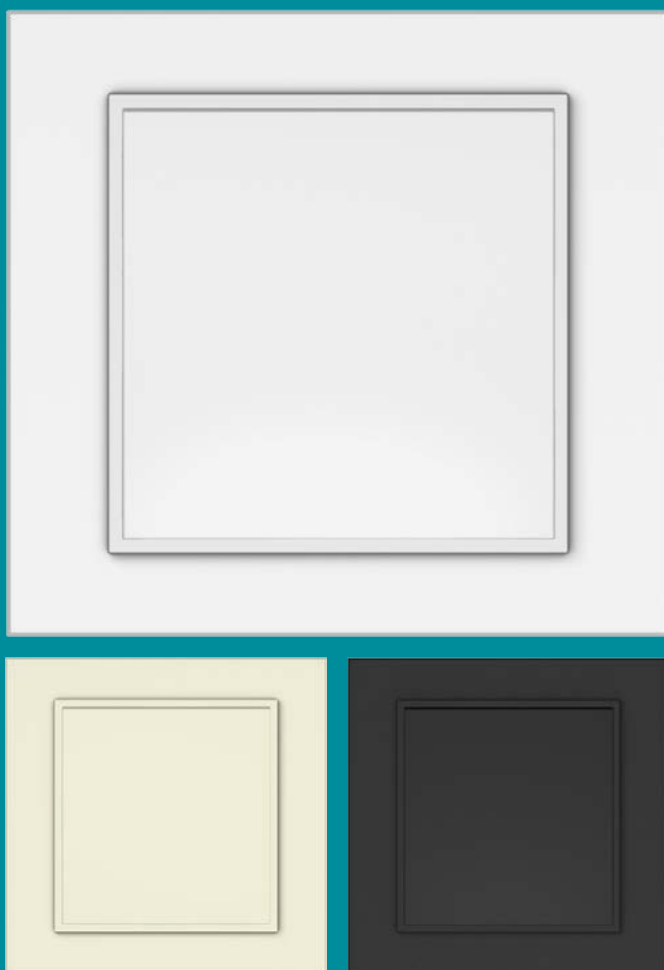

These are products of the latest series. The design of this series is modern, with particularly strict lines. The switch form is architecturally complete – of square shape, the frame is particularly thin and ideally blends with walls, integrating details of the interior.





# QUADRUM QR 1000

## SWITCHES



### 1-GANG SWITCH, WITHOUT FRAME

10 pcs. 10A, 250V~ IP20 PC

\*Article number \*\* EAN code (V)



White



Ivory



Black

\* P110-010-02 ww

P110-010-02 iv

P110-010-02 blc

\*\* 4779101117905

4779101118469

4779101119152



### 1-GANG SWITCH WITH ILLUMINATION, WITHOUT FRAME

10 pcs. 10A, 250V~ IP20 PC

\*Article number \*\* EAN code (V)



White



Ivory



Black

\* P110-010-12 ww

P110-010-12 iv

P110-010-12 blc

\*\* 4779101117912

4779101118476

4779101119169



### 1-GANG SWITCH (IP44), WITHOUT FRAME

10 pcs. 10A, 250V~ IP44 PC

\*Article number \*\* EAN code (V)



White



Ivory



Black

\* P110-010-04 ww

P110-010-04 iv

P110-010-04 blc

\*\* 4779101118193

4779101118759

4779101119831



### 2-GANG SWITCH, WITHOUT FRAME

10 pcs. 10A, 250V~ IP20 PC

\*Article number \*\* EAN code (V)



White



Ivory



Black

\* P510-020-02 ww

P510-020-02 iv

P510-020-02 blc

\*\* 4779101117929

4779101118483

4779101119176



### 2-GANG SWITCH WITH ILLUMINATION, WITHOUT FRAME

10 pcs. 10A, 250V~ IP20 PC

\*Article number \*\* EAN code (V)



White



Ivory



Black

\* P510-020-12 ww

P510-020-12 iv

P510-020-12 blc

\*\* 4779101117936

4779101118490

4779101119183

# QUADRUM QR 1000

## SWITCHES - TWO-WAY SWITCHES



### 2-GANG SWITCH (IP44), WITHOUT FRAME

10 pcs. 10A, 250V~ IP44 PC

\*Article number \*\* EAN code (V)



White



Ivory



Black

* P510-020-04 ww	P510-020-04 iv	P510-020-04 blc
** 4779101118230	4779101118797	4779101119879



### 1-GANG TWO-WAY SWITCH, WITHOUT FRAME

10 pcs. 10A, 250V~ IP20 PC

\*Article number \*\* EAN code (V)



White



Ivory



Black

* P610-010-02 ww	P610-010-02 iv	P610-010-02 blc
** 4779101117943	4779101118506	4779101119190



### 1-GANG TWO-WAY SWITCH WITH ILLUMINATION, WITHOUT FRAME

10 pcs. 10A, 250V~ IP20 PC

\*Article number \*\* EAN code (V)



White



Ivory



Black

* P610-010-12 ww	P610-010-12 iv	P610-010-12 blc
** 4779101117950	4779101118513	4779101119596



### 1-GANG TWO-WAY SWITCH (IP44), WITHOUT FRAME

10 pcs. 10A, 250V~ IP44 PC

\*Article number \*\* EAN code (V)



White



Ivory



Black

* P610-010-04 ww	P610-010-04 iv	P610-010-04 blc
** 4779101118209	4779101118766	4779101119848



### 2-GANG TWO-WAY SWITCH, WITHOUT FRAME

10 pcs. 10A, 250V~ IP20 PC

\*Article number \*\* EAN code (V)



White



Ivory



Black

* P(6+6)10-020-02 ww	P(6+6)10-020-02 iv	P(6+6)10-020-02 blc
** 4779101117967	4779101118520	4779101119206

# QUADRUN QR 1000

## TWO-WAY SWITCHES · PUSH-BUTTON SWITCHES



### 1-GANG INTERMEDIATE SWITCH, WITHOUT FRAME

10 pcs. 10A, 250V~ IP20 PC

\*Article number \*\* EAN code (V)



White



Ivory



Black

\* P710-010-02 ww

P710-010-02 iv

P710-010-02 blc

\*\* 4779101117974

4779101118537

4779101119213



### 1-GANG INTERMEDIATE SWITCH WITH ILLUMINATION, WITHOUT FRAME

10 pcs. 10A, 250V~ IP20 PC

\*Article number \*\* EAN code (V)



White



Ivory



Black

\* P710-010-12 ww

P710-010-12 iv

P710-010-12 blc

\*\* 4779101118155

4779101118711

4779101119794



### 1-GANG INTERMEDIATE SWITCH (IP44), WITHOUT FRAME

10 pcs. 10A, 250V~ IP44 PC

\*Article number \*\* EAN code (V)



White



Ivory



Black

\* P710-010-04 ww

P710-010-04 iv

P710-010-04 blc

\*\* 4779101118216

4779101118773

4779101119855



### 1-GANG PUSH-BUTTON SWITCH "BELL", WITH FRAME

10 pcs. 10A, 250V~ IP20 PC

\*Article number \*\* EAN code (V)



White



Ivory



Black

\* P110-012-02 ww

P110-012-02 iv

P110-012-02 blc

\*\* 4779101118001

4779101118568

4779101119640



### 1-GANG PUSH-BUTTON SWITCH "BELL" WITH ILLUMINATION, WITHOUT FRAME

10 pcs. 10A, 250V~ IP20 PC

\*Article number \*\* EAN code (V)



White



Ivory



Black

\* P110-012-12 ww

P110-012-12 iv

P110-012-12 blc

\*\* 4779101118018

4779101118575

4779101119657

# QUADRUN QR 1000

## PUSH-BUTTON SWITCHES · DIMMERS · SOCKET OUTLETS



### 1-GANG PUSH-BUTTON SWITCH "BELL" (IP44), WITHOUT FRAME

10 pcs. 10A, 250V~ IP44 PC

\*Article number \*\* EAN code (V)



White



Ivory



Black

\* P110-012-04 ww

P110-012-04 iv

P110-012-04 blc

\*\* 4779101118223

4779101118780

4779101119862

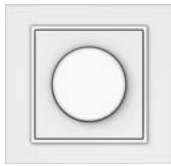

### ROTARY DIMMER (1-100 W) OF LED DIMMABLE LAMPS, WITH FRAME

10 pcs. 10A, 250V~ IP20 PC

\*Article number \*\* EAN code (V)



White



Ivory



Black

\* ARMP LED ww

ARMP LED iv

ARMP LED blc

\*\* 4779101118322

4779101118896

4779101119961



### SOCKET OUTLET, WITHOUT FRAME

10 pcs. 10A, 250V~ IP20 PC

\*Article number \*\* EAN code (V)



White



Ivory



Black

\* RP16-001-02 ww

RP16-001-02 iv

RP16-001-02 blc

\*\* 4779101118032

4779101118599

4779101119671



### SOCKET OUTLET WITH SHUTTERS, WITHOUT FRAME

10 pcs. 10A, 250V~ IP20 PC

\*Article number \*\* EAN code (V)



White



Ivory



Black

\* RP16-001-22 ww

RP16-001-22 iv

RP16-001-22 blc

\*\* 4779101118049

4779101118605

4779101119688



### SCHUKO SOCKET OUTLET, WITHOUT FRAME

10 pcs. 10A, 250V~ IP20 PC

\*Article number \*\* EAN code (V)



White



Ivory



Black

\* RP16-002-02 ww

RP16-002-02 iv

RP16-002-02 blc

\*\* 4779101118056

4779101118612

4779101119695

# QUADRUN QR 1000

## SOCKET OUTLETS



### SCHUKO SOCKET OUTLET WITH SHUTTERS, WITHOUT FRAME

10 pcs. 10A, 250V~ IP20 PC

\*Article number \*\* EAN code (V)



White



Ivory



Black

\* RP16-002-22 ww

RP16-002-22 iv

RP16-002-22 blc

\*\* 4779101118063

4779101118629

4779101119701



### E TYPE SOCKET OUTLET WITH SHUTTERS, WITHOUT FRAME

10 pcs. 10A, 250V~ IP20 PC

\*Article number \*\* EAN code (V)



White



Ivory



Black

\* RP16-002-10-22 ww

RP16-002-10-22 iv

RP16-002-10-22 blc

\*\* 4779101116663

4779101116687

4779101116700



### SCHUKO SOCKET OUTLET WITH HINGED LID (IP44), WITHOUT FRAME

10 pcs. 10A, 250V~ IP44 PC

\*Article number \*\* EAN code (V)



White



Ivory



Black

\* RP16-003-02 ww

RP16-003-02 iv

RP16-003-02 blc

\*\* 4779101118070

4779101118636

4779101119718



### SCHUKO SOCKET OUTLET WITH HINGED LID AND WITH SHUTTERS (IP44), WITHOUT FRAME

10 pcs. 10A, 250V~ IP44 PC

\*Article number \*\* EAN code (V)



White



Ivory



Black

\* RP16-003-22 ww

RP16-003-22 iv

RP16-003-22 blc

\*\* 4779101118087

4779101118643

4779101119725



### E TYPE SCHUKO SOCKET OUTLET WITH SHUTTERS (IP44), WITHOUT FRAME

10 pcs. 10A, 250V~ IP44 PC

\*Article number \*\* EAN code (V)



White



Ivory



Black

\* RP16-003-10-22 ww

RP16-003-10-22 iv

RP16-003-10-22 blc

\*\* 4779101116670

4779101116694

4779101116717

# QUADRUM QR 1000

## DATA OUTLETS · TV SOCKET OUTLETS



### 1-GANG DATA OUTLET (1XRJ45 CAT6E UTP), WITHOUT FRAME

10 pcs. IP20 PC

\*Article number \*\* EAN code (V)



White



Ivory



Black

* KLRJ45-16e2-02 ww	KLRJ45-16e2-02 iv	KLRJ45-16e2-02 blc
** 4779101118360	4779101118926	4779101120004



### 2-GANG DATA OUTLET (2XRJ45 CAT6E UTP), WITHOUT FRAME

10 pcs. IP20 PC

\*Article number \*\* EAN code (V)



White



Ivory



Black

* KLRJ45-26e2-02 ww	KLRJ45-26e2-02 iv	KLRJ45-26e2-02 blc
** 4779101118377	4779101118933	4779101120011



### TV SOCKET OUTLET, ENDING, WITHOUT FRAME

10 pcs. IP20 PC

\*Article number \*\* EAN code (V)



White



Ivory



Black

* TVL01-02 ww	TVL01-02 iv	TVL01-02 blc
** 4779101118094	4779101118650	4779101119732



### TV+DATA OUTLET (TV+RJ45), WITHOUT FRAME

10 pcs. IP20 PC

\*Article number \*\* EAN code (V)



White



Ivory



Black

* TVL/KLRJ45-16e2-02 ww	TVL/KLRJ45-16e2-02 iv	TVL/KLRJ45-16e2-02 blc
** 4779101118179	4779101118735	4779101119817



### SAT SOCKET OUTLET, ENDING, WITHOUT FRAME

10 pcs. IP20 PC

\*Article number \*\* EAN code (V)



White



Ivory



Black

* SAT01-02 ww	SAT01-02 iv	SAT01-02 blc
** 4779101118292	4779101118858	4779101119930

# QUADRUN QR 1000

## TV SOCKET OUTLETS



### SAT+DATA OUTLET (SAT+RJ45), WITHOUT FRAME

10 pcs. IP20 PC

\*Article number \*\* EAN code (V)



White



Ivory



Black

\* SAT/KLRJ45-15e2-02 wwSAT/KLRJ45-15e2-02 iv SAT/KLRJ45-15e2-02 blc

\*\* 4779101118308 4779101118865 4779101119947

# QUADRUNM QR 1000

## FRAMES



### 1-GANG FRAME

40 pcs. PC

\*Article number \*\* EAN code (V)



White



Ivory



Black

\* R01 ww

R01 iv

R01 blc

\*\* 4779101118100

4779101118667

4779101119749

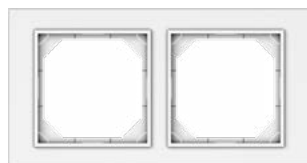

### 2-GANG FRAME

20 pcs. PC

\*Article number \*\* EAN code (V)



White



Ivory



Black

\* R02 ww

R02 iv

R02 blc

\*\* 4779101118117

4779101118674

4779101119756



### 3-GANG FRAME

15 pcs. PC

\*Article number \*\* EAN code (V)



White



Ivory



Black

\* R03 ww

R03 iv

R03 blc

\*\* 4779101118124

4779101118681

4779101119763

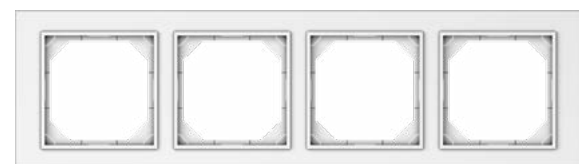

### 4-GANG FRAME

10 pcs. PC

\*Article number \*\* EAN code (V)



White



Ivory



Black

\* R04 ww

R04 iv

R04 blc

\*\* 4779101118131

4779101118698

4779101119770

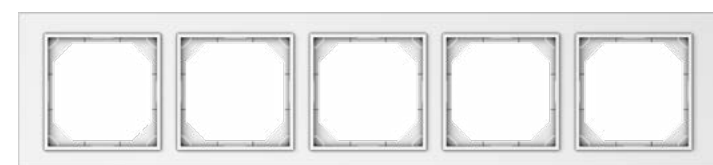

### 5-GANG FRAME

10 pcs. PC

\*Article number \*\* EAN code (V)



White



Ivory



Black

\* R05 ww

R05 iv

R05 blc

\*\* 4779101118148

4779101118704

4779101119787



# QUADRUM QR 1000

## GLASS AND WOODEN FRAMES

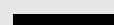

Not only plastic, but also wooden and glass frames have been created for **QUADRUM QR 1000** products. This enables to make the interior design complete to the smallest detail. If you want to integrate a switch in the interior modernly, a white glass frame is ideal for this. It has a matte finish and subtly blends into the surroundings. Meanwhile, black glass products have a gloss finish and serve as an accent in the interior.

Wooden frames create the feeling of cosiness, naturalness in the interior design. They are made of real wood so they are really pleasant to touch. You can choose a whitened or natural color oak frame if your interior is in pastel colors, whereas a darkened oak color frame suits a more intensive, more sensuous interior.

These exceptional frames can be matched with **QUADRUM QR 1000** mechanisms of three colors, in this way making the uniqueness of your interior more prominent.



# QUADRUM QR 1000

## WOODEN FRAMES



### 1-GANG FRAME WHITENED OAK

Article number R01 wwo  
EAN code (V) 4779101117806

8 pcs. Wood



### 2-GANG FRAME WHITENED OAK

Article number R02 wwo  
EAN code (V) 4779101117813

4 pcs.  
 Wood



### 3-GANG FRAME WHITENED OAK

Article number R03 wwo  
EAN code (V) 4779101117820

4 pcs.  
 Wood



### 4-GANG FRAME WHITENED OAK

Article number R04 wwo  
EAN code (V) 4779101117837

4 pcs.  
 Wood



### 1-GANG FRAME OAK

Article number R01 wno  
EAN code (V) 4779101117608

8 pcs. Wood



### 2-GANG FRAME OAK

Article number R02 wno  
EAN code (V) 4779101117615

4 pcs.  
 Wood



### 3-GANG FRAME OAK

Article number R03 wno  
EAN code (V) 4779101117622

4 pcs.  
 Wood



### 4-GANG FRAME OAK

Article number R04 wno  
EAN code (V) 4779101117769

4 pcs.  
 Wood

# QUADRUM QR 1000

## WOODEN FRAMES

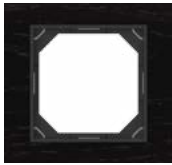

### 1-GANG FRAME DARK OAK



Article number R01 wdo  
EAN code (V) 4779101117851

 8 pcs.  Wood



### 2-GANG FRAME DARK OAK



Article number R02 wdo  
EAN code (V) 4779101117868

 4 pcs.  
 Wood



### 3-GANG FRAME DARK OAK



Article number R03 wdo  
EAN code (V) 4779101117875

 4 pcs.  
 Wood



### 4-GANG FRAME DARK OAK

Article number R04 wdo  
EAN code (V) 4779101117882

 4 pcs.  
 Wood

# QUADRUM QR 1000

## GLASS FRAMES



### 1-GANG FRAME FROSTED WHITE GLASS

Article number R01 gmw  
EAN code (V) 4779101117660

8 pcs. Glass

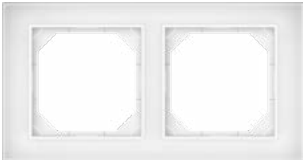

### 2-GANG FRAME FROSTED WHITE GLASS

Article number R02 gmw  
EAN code (V) 4779101117677

4 pcs.  
 Glass

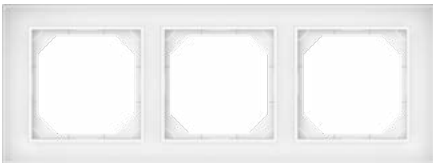

### 3-GANG FRAME FROSTED WHITE GLASS

Article number R03 gmw  
EAN code (V) 4779101117684

4 pcs.  
 Glass

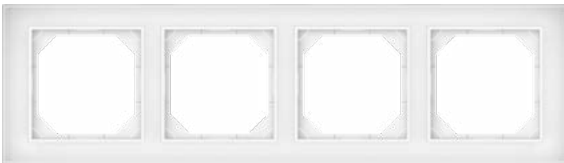

### 4-GANG FRAME FROSTED WHITE GLASS

Article number R04 gmw  
EAN code (V) 4779101117691

4 pcs.  
 Glass



### 1-GANG FRAME BLACK GLASS

Article number R01 gcb  
EAN code (V) 4779101117714

8 pcs. Glass



### 2-GANG FRAME BLACK GLASS

Article number R02 gcb  
EAN code (V) 4779101117721

4 pcs.  
 Glass



### 3-GANG FRAME BLACK GLASS

Article number R03 gcb  
EAN code (V) 4779101117738

4 pcs.  
 Glass



### 4-GANG FRAME BLACK GLASS

Article number R04 gcb  
EAN code (V) 4779101117745

4 pcs.  
 Glass



# EXPRESS XP 500

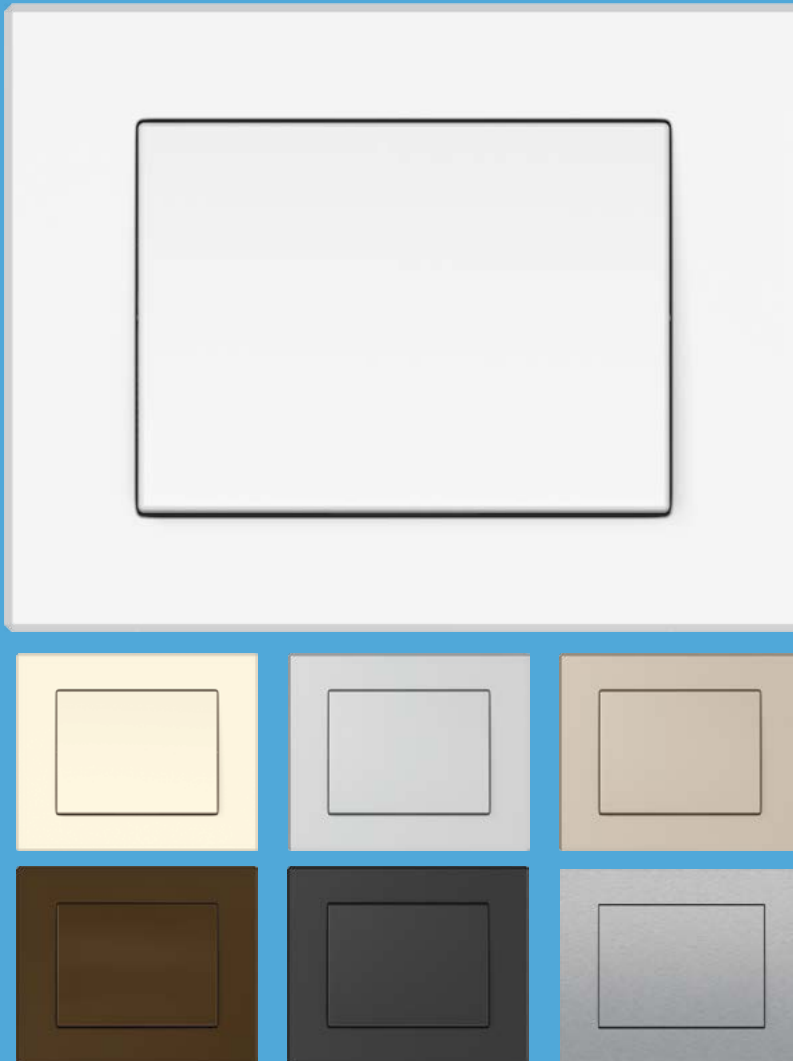

**EXPRESS XP 500** series features a unique rectangular shape and streamlined design elements. Products with glass stand out for their modernity and elegance, while natural wood provides warmth and comfort to the surroundings. With a wide range of colours, materials and functions to choose from, you can create a coordinated and exquisite interior in your home or other spaces.





# EXPRESS XP 500

## SWITCHES



### 1-GANG SWITCH, WITHOUT FRAME

10 pcs. 10A, 250V~ IP20 PC

\*Article number \*\* EAN code (V)



White



Ivory



Metallic



Champagne



Brown



Anthracite



Steel

\* P110-010-02 ww

P110-010-02 iv

P110-010-02 mt

P110-010-02 ch

P110-010-02 br

P110-010-02 an

P110-010-02 stl

\*\* 4779101210293

4779101211290

4779101219265

4779101216271

4779101213010

4779101217018

4779101216370



### 1-GANG SWITCH WITH ILLUMINATION, WITHOUT FRAME

10 pcs. 10A, 250V~ IP20 PC

\*Article number \*\* EAN code (V)



White



Ivory



\* Metallic



\* Champagne



\* Brown



\* Anthracite

\* P110-010-12 ww

P110-010-12 iv

P110-010-12 mt

P110-010-12 ch

P110-010-12 br

P110-010-12 an

\*\* 4779101210309

4779101211306

4779101219272

4779101216288

4779101213027

4779101217025



### 1-GANG SWITCH (IP44), WITHOUT FRAME

10 pcs. 10A, 250V~ IP44 PC

\*Article number \*\* EAN code (V)



White



Ivory



Metallic



Champagne



Brown



Anthracite



Steel

\* P110-010-04 ww

P110-010-04 iv

P110-010-04 mt

P110-010-04 ch

P110-010-04 br

P110-010-04 an

P110-010-04 stl

\*\* 4779101210545

4779101211535

4779101219340

4779101216295

4779101213164

4779101217520

4779101216400

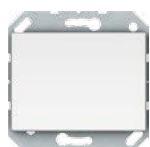

### 1-GANG 2 POLE SWITCH, WITHOUT FRAME

10 pcs. 10A, 250V~ IP20 PC Production by the order

\*Article number \*\* EAN code (V)



White



Ivory



Metallic



Champagne



Brown



Anthracite

\* P210-010-02 ww

P210-010-02 iv

P210-010-02 mt

P210-010-02 ch

P210-010-02 br

P210-010-02 an

\*\* 4779101410532

4779101411539

4779101419559

4779101416305

4779101413069

4779101417067



### 1-GANG 2 POLE SWITCH WITH ILLUMINATION, WITHOUT FRAME

10 pcs. 10A, 250V~ IP20 PC Production by the order

\*Article number \*\* EAN code (V)



White



Ivory



\* Metallic



\* Champagne



\* Brown



\* Anthracite

\* P210-010-12 ww

P210-010-12 iv

P210-010-12 mt

P210-010-12 ch

P210-010-12 br

P210-010-12 an

\*\* 4779101410594

4779101411591

4779101419566

4779101416312

4779101413076

4779101417074

# EXPRESS XP 500

## SWITCHES



### 1-GANG 2 POLE SWITCH (IP44), WITHOUT FRAME

10 pcs. 10A, 250V~ IP44 PC Production by the order

\*Article number \*\* EAN code (V)



White



Ivory



Metallic



Champagne



Brown



Anthracite

\* P210-010-04 ww

P210-010-04 iv

P210-010-04 mt

P210-010-04 ch

P210-010-04 br

P210-010-04 an

\*\* 4779101410716

4779101411713

4779101419641

4779101416329

4779101413502

4779101417111



### 1-GANG SWITCH WITH INDICATOR LIGHT, WITHOUT FRAME

10 pcs. 10A, 250V~ IP20 PC

\*Article number \*\* EAN code (V)



White



Ivory



Metallic



Champagne



Brown



Anthracite

\* P110-010-22 ww

P110-010-22 iv

P110-010-22 mt

P110-010-22 ch

P110-010-22 br

P110-010-22 an

\*\* 4779101810066

4779101811063

4779101419597

4779101816631

4779101413083

4779101417104



### 2-GANG SWITCH, WITHOUT FRAME

10 pcs. 10A, 250V~ IP20 PC

\*Article number \*\* EAN code (V)



White



Ivory



Metallic



Champagne



Brown



Anthracite



Steel

\* P510-020-02 ww

P510-020-02 iv

P510-020-02 mt

P510-020-02 ch

P510-020-02 br

P510-020-02 an

P510-020-02 stl

\*\* 4779101210316

4779101211313

4779101219289

4779101216301

4779101213034

4779101217032

4779101216455



### 2-GANG SWITCH WITH ILLUMINATION, WITHOUT FRAME

10 pcs. 10A, 250V~ IP20 PC

\*Article number \*\* EAN code (V)



White



Ivory



Metallic



Champagne



Brown



Anthracite

\* P510-020-12 ww

P510-020-12 iv

P510-020-12 mt

P510-020-12 ch

P510-020-12 br

P510-020-12 an

\*\* 4779101210323

4779101211320

4779101219296

4779101216318

4779101213041

4779101217049



### 2-GANG SWITCH (IP44), WITHOUT FRAME

10 pcs. 10A, 250V~ IP44 PC

\*Article number \*\* EAN code (V)



White



Ivory



Metallic



Champagne



Brown



Anthracite



Steel

\* P510-020-04 ww

P510-020-04 iv

P510-020-04 mt

P510-020-04 ch

P510-020-04 br

P510-020-04 an

P510-020-04 stl

\*\* 4779101210576

4779101211573

4779101219388

4779101216363

4779101213195

4779101217568

4779101216448

# EXPRESS XP 500

## SWITCHES · TWO-WAY SWITCHES



### 3-GANG SWITCH, WITHOUT FRAME

10 pcs. 10A, 250V~ IP20 PC

\*Article number \*\* EAN code (V)



White



Ivory



Metallic



Champagne



Brown



Anthracite

\* P510-030-02 ww

P510-030-02 iv

P510-030-02 mt

P510-030-02 ch

P510-030-02 br

P510-030-02 an

\*\* 4779101210590

4779101211597

4779101219401

4779101216325

4779101213201

4779101217575



### CARD SWITCH, WITHOUT FRAME

10 pcs. 10A, 250V~ IP20 PC

Production by the order

\*Article number \*\* EAN code (V)



White



Ivory



Anthracite

\* P110-012-03 ww

P110-012-03 iv

P110-012-03 an

\*\* 4779101810363

4779101811476

4779101417302



### 1-GANG TWO-WAY SWITCH, WITHOUT FRAME

10 pcs. 10A, 250V~ IP20 PC

\*Article number \*\* EAN code (V)



White



Ivory



Metallic



Champagne



Brown



Anthracite



Steel

\* P610-010-02 ww

P610-010-02 iv

P610-010-02 mt

P610-010-02 ch

P610-010-02 br

P610-010-02 an

P610-010-02 stl

\*\* 4779101210330

4779101211337

4779101219302

4779101216332

4779101213058

4779101217056

4779101216486



### 1-GANG TWO-WAY SWITCH WITH ILLUMINATION, WITHOUT FRAME

10 pcs. 10A, 250V~ IP20 PC

\*Article number \*\* EAN code (V)



White



Ivory



Metallic



Champagne



Brown



Anthracite

\* P610-010-12 ww

P610-010-12 iv

P610-010-12 mt

P610-010-12 ch

P610-010-12 br

P610-010-12 an

\*\* 4779101210347

4779101211344

4779101219319

4779101216349

4779101213065

4779101217063



### 1-GANG TWO-WAY SWITCH (IP44), WITHOUT FRAME

10 pcs. 10A, 250V~ IP44 PC

\*Article number \*\* EAN code (V)



White



Ivory



Metallic



Champagne



Brown



Anthracite

\* P610-010-04 ww

P610-010-04 iv

P610-010-04 mt

P610-010-04 ch

P610-010-04 br

P610-010-04 an

\*\* 4779101210569

4779101211566

4779101219371

4779101216356

4779101213171

4779101217544

# EXPRESS XP 500

## TWO-WAY SWITCHES



### 2-GANG TWO-WAY SWITCH, WITHOUT FRAME

10 pcs. 10A, 250V~ IP20 PC

\*Article number \*\* EAN code (V)



White



Ivory



Metallic



Champagne



Brown



Anthracite



Steel

* P(6+6)10-020-02 ww	P(6+6)10-020-02 iv	P(6+6)10-020-02 mt	P(6+6)10-020-02 ch	P(6+6)10-020-02 br	P(6+6)10-020-02 an	P(6+6)10-020-02 stl
** 4779101410495	4779101411492	4779101419504	4779101416336	4779101413014	4779101417012	4779101416510



### 2-GANG TWO-WAY SWITCH (IP44), WITHOUT FRAME

10 pcs. 10A, 250V~ IP44 PC

\*Article number \*\* EAN code (V)



White



Ivory



Metallic



Champagne



Brown



Anthracite

* P(6+6)10-020-04 ww	P(6+6)10-020-04 iv	P(6+6)10-020-04 mt	P(6+6)10-020-04 ch	P(6+6)10-020-04 br	P(6+6)10-020-04 an
** 4779101410792	4779101411799	4779101419672	4779101416398	4779101413526	4779101417173



### 3-GANG TWO-WAY SWITCH, WITHOUT FRAME

10 pcs. 10A, 250V~ IP20 PC Production by the order

\*Article number \*\* EAN code (V)



White



Ivory



Metallic



Champagne



Brown



Anthracite

* P(6+6+6)10-030-02 ww	P(6+6+6)10-030-02 iv	P(6+6+6)10-030-02 mt	P(6+6+6)10-030-02 ch	P(6+6+6)10-030-02 br	P(6+6+6)10-030-02 an
** 4779101410839	4779101411089	4779101419054	4779101416633	4779101413137	4779101417289



### 3-GANG TWO-WAY SWITCH (IP44), WITHOUT FRAME

10 pcs. 10A, 250V~ IP44 PC

\*Article number \*\* EAN code (V)



White



Ivory



Metallic



Champagne



Brown



Anthracite

* P(6+6+6)10-030-04 ww	P(6+6+6)10-030-04 iv	P(6+6+6)10-030-04 mt	P(6+6+6)10-030-04 ch	P(6+6+6)10-030-04 br	P(6+6+6)10-030-04 an
** 4779101410846	4779101411096	4779101419061	4779101416473	4779101413144	4779101417296



### 1-GANG INTERMEDIATE SWITCH, WITHOUT FRAME

10 pcs. 10A, 250V~ IP20 PC

\*Article number \*\* EAN code (V)



White



Ivory



Metallic



Champagne



Brown



Anthracite



Steel

* P710-010-02 ww	P710-010-02 iv	P710-010-02 mt	P710-010-02 ch	P710-010-02 br	P710-010-02 an	P710-010-02 stl
** 4779101410501	4779101411508	4779101419511	4779101416343	4779101413021	4779101417029	4779101416558

# EXPRESS XP 500

## TWO-WAY SWITCHES · PUSH-BUTTON SWITCHES



### 1-GANG INTERMEDIATE SWITCH WITH ILLUMINATION, WITHOUT FRAME

10 pcs. 10A, 250V~ IP20 PC

\*Article number \*\* EAN code (V)



White



Ivory



\* Metallic



\* Champagne



\* Brown



\* Anthracite

\* P710-010-12 ww

P710-010-12 iv

P710-010-12 mt

P710-010-12 ch

P710-010-12 br

P710-010-12 an

\*\* 4779101410587

4779101411584

4779101419528

4779101416350

4779101413038

4779101417036



### 1-GANG INTERMEDIATE SWITCH (IP44), WITHOUT FRAME

10 pcs. 10A, 250V~ IP44 PC

\*Article number \*\* EAN code (V)



White



Ivory



Metallic



Champagne



Brown



Anthracite

\* P710-010-04 ww

P710-010-04 iv

P710-010-04 mt

P710-010-04 ch

P710-010-04 br

P710-010-04 an

\*\* 4779101410761

4779101411768

4779101419658

4779101416381

4779101413519

4779101417142



### 1-GANG PUSH-BUTTON SWITCH, WITHOUT FRAME

10 pcs. 10A, 250V~ IP20 PC Production by the order

\*Article number \*\* EAN code (V)



White



Ivory



Metallic



Champagne



Brown



Anthracite

\* P110-012-22 ww

P110-012-22 iv

P110-012-22 mt

P110-012-22 ch

P110-012-22 br

P110-012-22 an

\*\* 4779101810110

4779101811124

4779101819045

4779101816662

4779101813043

4779101817096



### 1-GANG PUSH-BUTTON SWITCH WITH ILLUMINATION, WITHOUT FRAME

10 pcs. 10A, 250V~ IP20 PC Production by the order

\*Article number \*\* EAN code (V)



White



Ivory



\* Metallic



\* Champagne



\* Brown



\* Anthracite

\* P110-012-32 ww

P110-012-32 iv

P110-012-32 mt

P110-012-32 ch

P110-012-32 br

P110-012-32 an

\*\* 4779101810172

4779101811186

4779101819090

4779101816686

4779101813067

4779101817133



### 1-GANG PUSH-BUTTON SWITCH (IP44), WITHOUT FRAME

10 pcs. 10A, 250V~ IP44 PC Production by the order

\*Article number \*\* EAN code (V)



White



Ivory



Metallic



Champagne



Brown



Anthracite

\* P110-012-24 ww

P110-012-24 iv

P110-012-24 mt

P110-012-24 ch

P110-012-24 br

P110-012-24 an

\*\* 4779101810301

4779101811315

4779101819175

4779101816709

4779101813128

4779101817188

# EXPRESS XP 500

## PUSH-BUTTON SWITCHES · PUSH-BUTTON SWITCHES “BELL”



### 2-GANG PUSH-BUTTON SWITCH, WITHOUT FRAME

10 pcs. 10A, 250V~ IP20 PC Production by the order

\*Article number \*\* EAN code (V)



White



Ivory



Metallic



Champagne



Brown



Anthracite



Steel

\* P410-020-22 ww  
\*\* 4779101810127

P410-020-22 iv  
4779101811131

P410-020-22 mt  
4779101819052

P410-020-22 ch  
4779101816679

P410-020-22 br  
4779101813050

P410-020-22 an  
4779101817102

P410-020-22 stl  
4779101416893



### 2-GANG PUSH-BUTTON SWITCH WITH ILLUMINATION, WITHOUT FRAME

10 pcs. 10A, 250V~ IP20 PC Production by the order

\*Article number \*\* EAN code (V)



White



Ivory



Metallic



Champagne



Brown



Anthracite

\* P410-020-32 ww  
\*\* 4779101810189

P410-020-32 iv  
4779101811193

P410-020-32 mt  
4779101819106

P410-020-32 ch  
4779101416404

P410-020-32 br  
4779101813074

P410-020-32 an  
4779101817140



### 2-GANG PUSH-BUTTON SWITCH (IP44), WITHOUT FRAME

10 pcs. 10A, 250V~ IP44 PC Production by the order

\*Article number \*\* EAN code (V)



White



Ivory



Metallic



Champagne



Brown



Anthracite

\* P410-020-24 ww  
\*\* 4779101810349

P410-020-24 iv  
4779101811353

P410-020-24 mt  
4779101819199

P410-020-24 ch  
4779101816723

P410-020-24 br  
4779101813135

P410-020-24 an  
4779101817201



### 1-GANG PUSH-BUTTON SWITCH “BELL”, WITH FRAME

10 pcs. 10A, 250V~ IP20 PC

\*Article number \*\* EAN code (V)



White



Ivory



Metallic



Champagne



Brown



Anthracite



Steel

\* P110-012-02 ww  
\*\* 4779101810042

P110-012-02 iv  
4779101811070

P110-012-02 mt  
4779101419573

P110-012-02 ch  
4779101816648

P110-012-02 br  
4779101213119

P110-012-02 an  
4779101417081

P110-012-02 stl  
4779101816860



### 1-GANG PUSH-BUTTON SWITCH “BELL” WITH ILLUMINATION, WITHOUT FRAME

10 pcs. 10A, 250V~ IP20 PC

\*Article number \*\* EAN code (V)



White



Ivory



\* Metallic



\* Champagne



\* Brown



\* Anthracite

\* P110-012-12 ww  
\*\* 4779101810059

P110-012-12 iv  
4779101811056

P110-012-12 mt  
4779101419580

P110-012-12 ch  
4779101816655

P110-012-12 br  
4779101213126

P110-012-12 an  
4779101417098

# EXPRESS XP 500

## PUSH-BUTTON SWITCHES "BELL" · BLINDS SWITCHES · DIMMERS



### 1-GANG PUSH-BUTTON SWITCH "BELL" (IP44), WITHOUT FRAME

10 pcs. 10A, 250V~ IP44 PC

\*Article number \*\* EAN code (V)



White



Ivory



Metallic



Champagne



Brown



Anthracite

\* P110-012-04 ww

P110-012-04 iv

P110-012-04 mt

P110-012-04 ch

P110-012-04 br

P110-012-04 an

\*\* 4779101810325

4779101811339

4779101419665

4779101816716

4779101213188

4779101417159



### 2-GANG BLIND SWITCH, WITHOUT FRAME

10 pcs. 10A, 250V~ IP20 PC

\*Article number \*\* EAN code (V)



White



Ivory



Metallic



Champagne



Brown



Anthracite

\* P410-020-02 ww

P410-020-02 iv

P410-020-02 mt

P410-020-02 ch

P410-020-02 br

P410-020-02 an

\*\* 4779101410518

4779101411515

4779101419535

4779101416367

4779101413045

4779101417043



### 2-GANG BLIND SWITCH WITH ILLUMINATION, WITHOUT FRAME

10 pcs. 10A, 250V~ IP20 PC

\*Article number \*\* EAN code (V)



White



Ivory



Metallic



Champagne



Brown



Anthracite

\* P410-020-12 ww

P410-020-12 iv

P410-020-12 mt

P410-020-12 ch

P410-020-12 br

P410-020-12 an

\*\* 4779101410525

4779101411522

4779101419542

4779101416374

4779101413052

4779101417050



### 2-GANG BLIND SWITCH (IP44), WITHOUT FRAME

10 pcs. 10A, 250V~ IP44 PC

\*Article number \*\* EAN code (V)



White



Ivory



Metallic



Champagne



Brown



Anthracite

\* P410-020-04 ww

P410-020-04 iv

P410-020-04 mt

P410-020-04 ch

P410-020-04 br

P410-020-04 an

\*\* 4779101410822

4779101411829

4779101419689

4779101416404

4779101413533

4779101417197



### ROTARY DIMMER (20-400 W) OF LIGHT BULBS AND HV HALOGEN LAMPS, WITH FRAME

6 pcs. 250V~, 50Hz IP20 PC

\*Article number \*\* EAN code (V)



White



Ivory



Metallic



Champagne



Brown



Anthracite



Steel

\* ARMPM400 ww

ARMPM400 iv

ARMPM400 mt

ARMPM400 ch

ARMPM400 br

ARMPM400 an

ARMPM400 stl

\*\* 4779101910544

4779101911541

4779101919530

4779101916225

4779101913491

4779101917543

4779101916256

# EXPRESS XP 500

## DIMMERS AND THERMOSTATS



### ROTARY DIMMER (40-600 W) OF LIGHT BULBS AND HV HALOGEN LAMPS, WITH FRAME

6 pcs. ⚡ 250V~, 50Hz IP20 PC

\*Article number \*\* EAN code (V)



White



Ivory



Metallic



Champagne



Brown



Anthracite

\* ARMPM600 ww

ARMPM600 iv

ARMPM600 mt

ARMPM600 ch

ARMPM600 br

ARMPM600 an

\*\* 4779101910551

4779101911558

4779101919547

4779101916232

4779101913507

4779101917550



### ROTARY DIMMER (1-100 W) OF LED DIMMABLE LAMPS, WITH FRAME

6 pcs. ⚡ 250V~, 50Hz IP20 PC

\*Article number \*\* EAN code (V)



White



Ivory



Metallic



Champagne



Brown



Anthracite

\* ARMP LED ww

ARMP LED iv

ARMP LED mt

ARMP LED ch

ARMP LED br

ARMP LED an

\*\* 4779101910773

4779101911619

4779101919592

4779101916218

4779101913545

4779101917598



### ROTARY DIMMER (1-200 W) OF LED DIMMABLE LAMPS, WITH FRAME

6 pcs. ⚡ 250V~, 50Hz IP20 PC

\*Article number \*\* EAN code (V)



White



Ivory



Metallic



Champagne



Brown



Anthracite

\* ARMPLED1-200 ww

ARMPLED1-200 iv

ARMPLED1-200 mt

ARMPLED1-200 ch

ARMPLED1-200 br

ARMPLED1-200 an

\*\* 4779101610680

4779101610727

4779101610697

4779101610741

4779101610734

4779101610710



### ROOM THERMOSTAT, WITHOUT FRAME

4 pcs. ⚡ 230V~, 50Hz IP20 PC

\*Article number \*\* EAN code (V)



White



Ivory



Metallic



Champagne



Brown



Anthracite

\* Fre R2A ww

Fre R2A iv

Fre R2A mt

Fre R2A ch

Fre R2A br

Fre R2A an

\*\* 4779101910797

4779101911909

4779101919738

4779101916201

4779101913637

4779101917604



### FLOOR THERMOSTAT, WITHOUT FRAME

4 pcs. ⚡ 230V~, 50Hz~ IP20 PC

\*Article number \*\* EAN code (V)



White



Ivory



Metallic



Champagne



Brown



Anthracite

\* Fre F2A ww

Fre F2A iv

Fre F2A mt

Fre F2A ch

Fre F2A br

Fre F2A an

\*\* 4779101910575

4779101911572

4779101919561

4779101916195

4779101913538

4779101917567



# EXPRESS XP 500

## SOCKET OUTLETS

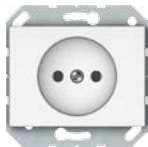

### SOCKET OUTLET, WITHOUT FRAME

10 pcs. 16A, 250V~ IP20 PC

\*Article number \*\* EAN code (V)



White



Ivory



Metallic



Champagne



Brown



Anthracite

* RP16-001-02 ww	RP16-001-02 iv	RP16-001-02 mt	RP16-001-02 ch	RP16-001-02 br	RP16-001-02 an
** 4779101110388	4779101111385	4779101119336	4779101116304	4779101113075	4779101117011



### SOCKET OUTLET WITH SHUTTERS, WITHOUT FRAME

10 pcs. 16A, 250V~ IP20 PC

\*Article number \*\* EAN code (V)



White



Ivory



Metallic



Champagne



Brown



Anthracite

* RP16-001-22 ww	RP16-001-22 iv	RP16-001-22 mt	RP16-001-22 ch	RP16-001-22 br	RP16-001-22 an
** 4779101110395	4779101111392	4779101119343	4779101116311	4779101113082	4779101117028



### SCHUKO SOCKET OUTLET, WITHOUT FRAME

10 pcs. 16A, 250V~ IP20 PC

\*Article number \*\* EAN code (V)



White



Ivory



Metallic



Champagne



Brown



Anthracite



Steel

* RP16-002-02 ww	RP16-002-02 iv	RP16-002-02 mt	RP16-002-02 ch	RP16-002-02 br	RP16-002-02 an	RP16-002-02 stl
** 4779101110401	4779101111408	4779101119350	4779101116328	4779101113099	4779101117035	477910116724



### SCHUKO SOCKET OUTLET WITH SHUTTERS, WITHOUT FRAME

10 pcs. 16A, 250V~ IP20 PC

\*Article number \*\* EAN code (V)



White



Ivory



Metallic



Champagne



Brown



Anthracite



Steel

* RP16-002-22 ww	RP16-002-22 iv	RP16-002-22 mt	RP16-002-22 ch	RP16-002-22 br	RP16-002-22 an	RP16-002-22 stl
** 4779101110418	4779101111415	4779101119367	4779101116335	4779101113105	4779101117042	477910116731



### E TYPE OUTLET WITH SHUTTERS, WITHOUT FRAME

10 pcs. 16A, 250V~ IP20 PC

\*Article number \*\* EAN code (V)



White



Ivory



Metallic



Anthracite

* RP16-002-10-22 ww	RP16-002-10-22 iv	RP16-002-10-22 mt	RP16-002-10-22 an
** 4779101110753	4779101116601	4779101116632	4779101117370

# EXPRESS XP 500

## SOCKET OUTLETS



### SCHUKO SOCKET OUTLET WITH HINGED LID (IP44), WITHOUT FRAME

10 pcs. 16A, 250V~ IP44 PC

\*Article number \*\* EAN code (V)



White



Ivory



Metallic



Champagne



Brown



Anthracite

\* RP16-003-02 ww

RP16-003-02 iv

RP16-003-02 mt

RP16-003-02 ch

RP16-003-02 br

RP16-003-02 an

\*\* 4779101110425

4779101111422

4779101119374

4779101116342

4779101113112

4779101117059



### SCHUKO SOCKET OUTLET WITH HINGED LID AND WITH SHUTTERS (IP44), WITHOUT FRAME

10 pcs. 16A, 250V~ IP44 PC

\*Article number \*\* EAN code (V)



White



Ivory



Metallic



Champagne



Brown



Anthracite

\* RP16-003-22 ww

RP16-003-22 iv

RP16-003-22 mt

RP16-003-22 ch

RP16-003-22 br

RP16-003-22 an

\*\* 4779101110432

4779101111439

4779101119381

4779101116359

4779101113129

4779101117066



### E TYPE SOCKET OUTLET WITH SHUTTERS (IP44), WITHOUT FRAME

10 pcs. 16A, 250V~ IP44 PC

\*Article number \*\* EAN code (V)



White



Ivory



Metallic



Anthracite

\* RP16-003-10-22 ww

RP16-003-10-22 iv

RP16-003-10-22 mt

RP16-003-10-22 an

\*\* 4779101110760

4779101116618

4779101116649

4779101117387

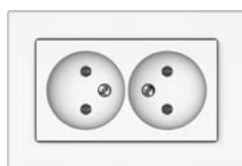

### 2-GANG SOCKET OUTLET

6 pcs. 16A, 250V~ IP20 PC

\*Article number \*\* EAN code (V)



White



Ivory



Metallic



Champagne



Brown



Anthracite

\* RP16-020 ww

RP16-020 iv

RP16-020 mt

RP16-020 ch

RP16-020 br

RP16-020 an

\*\* 4779101110449

4779101111446

4779101119398

4779101116366

4779101113143

4779101117073

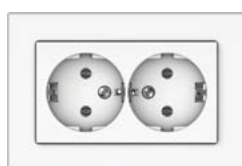

### SCHUKO 2-GANG SOCKET OUTLET

5 pcs. 16A, 250V~ IP20 PC

\*Article number \*\* EAN code (V)



White



Ivory



Metallic



Champagne



Brown



Anthracite

\* RP16-021 ww

RP16-021 iv

RP16-021 mt

RP16-021 ch

RP16-021 br

RP16-021 an

\*\* 4779101110487

4779101111484

4779101119404

4779101116373

4779101113136

4779101117080

# EXPRESS XP 500

## TELEPHONE AND DATA OUTLETS

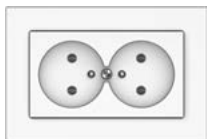

### E TYPE 2-GANG SOCKET OUTLET

10 pcs. IP20 PC

\*Article number \*\* EAN code (V)

White Ivory Metallic Anthracite

* RP16-024 ww	RP16-024 iv	RP16-024 mt	RP16-024 an
** 4779101110777	4779101116625	4779101116656	4779101117394



### 1-GANG TELEPHONE OUTLET (1XRJ11 CAT3E), WITHOUT FRAME

10 pcs. IP20 PC

\*Article number \*\* EAN code (V)

White Ivory Metallic Champagne Brown Anthracite

* TLRJ11-131-02 ww	TLRJ11-131-02 iv	TLRJ11-131-02 mt	TLRJ11-131-02 ch	TLRJ11-131-02 br	TLRJ11-131-02 an
** 4779101630565	4779101631562	4779101639643	4779101636536	4779101633016	4779101617016



### 2-GANG TELEPHONE OUTLET (2XRJ11 CAT3E), WITHOUT FRAME

10 pcs. IP20 PC Production by the order

\*Article number \*\* EAN code (V)

White Ivory Metallic Champagne Brown Anthracite

* TLRJ11-231-02 ww	TLRJ11-231-02 iv	TLRJ11-231-02 mt	TLRJ11-231-02 ch	TLRJ11-231-02 br	TLRJ11-231-02 an
** 4779101630596	4779101631593	4779101639674	4779101636543	4779101633047	4779101617047



### TELEPHONE AND DATA OUTLET (RJ11+RJ45 CAT3+CAT5E UTP), WITHOUT FRAME

10 pcs. IP20 PC

\*Article number \*\* EAN code (V)

White Ivory Metallic Champagne Brown Anthracite

* TKLRJ-35e2-02 ww	TKLRJ-35e2-02 iv	TKLRJ-35e2-02 mt	TKLRJ-35e2-02 ch	TKLRJ-35e2-02 br	TKLRJ-35e2-02 an
** 4779101630626	4779101631623	4779101639704	4779101636598	4779101633078	4779101617078



### 1-GANG DATA OUTLET (1XRJ45 CAT5E UTP), WITHOUT FRAME

10 pcs. IP20 PC

\*Article number \*\* EAN code (V)

White Ivory Metallic Champagne Brown Anthracite Black

* KLRJ45-15e2-02 ww	KLRJ45-15e2-02 iv	KLRJ45-15e2-02 mt	KLRJ45-15e2-02 ch	KLRJ45-15e2-02 br	KLRJ45-15e2-02 an	KLRJ45-15e2-02 blc
** 4779101630572	4779101631579	4779101639650	4779101636550	4779101633023	4779101617023	4779101636789

# EXPRESS XP 500

## TELEPHONE AND DATA OUTLETS - USB AND HDMI OUTLETS



### 2-GANG DATA OUTLET (2XRJ45 CAT5E UTP), WITHOUT FRAME

10 pcs. IP20 PC

\*Article number \*\* EAN code (V)



White



Ivory



Metallic



Champagne



Brown



Anthracite



Black

* KLRJ45-25e2-02 ww	KLRJ45-25e2-02 iv	KLRJ45-25e2-02 mt	KLRJ45-25e2-02 ch	KLRJ45-25e2-02 br	KLRJ45-25e2-02 an	KLRJ45-25e2-02 blc
** 4779101630602	4779101631609	4779101639681	4779101636574	4779101633054	4779101617054	4779101636796



### 1-GANG DATA OUTLET (1XRJ45 CAT5E UTP AMP), WITHOUT FRAME

10 pcs. IP20 PC

\*Article number \*\* EAN code (V)



White



Ivory



Metallic



Champagne



Brown



Anthracite

* KLRJ45-15e1-02 ww	KLRJ45-15e1-02 iv	KLRJ45-15e1-02 mt	KLRJ45-15e1-02 ch	KLRJ45-15e1-02 br	KLRJ45-15e1-02 an
** 4779101630589	4779101631586	4779101639667	4779101636567	4779101633030	4779101617030



### 2-GANG DATA OUTLET (2XRJ45 CAT5E UTP AMP), WITHOUT FRAME

10 pcs. IP20 PC

\*Article number \*\* EAN code (V)



White



Ivory



Metallic



Champagne



Brown



Anthracite

* KLRJ45-25e1-02 ww	KLRJ45-25e1-02 iv	KLRJ45-25e1-02 mt	KLRJ45-25e1-02 ch	KLRJ45-25e1-02 br	KLRJ45-25e1-02 an
** 4779101630619	4779101631616	4779101639698	4779101636581	4779101633061	4779101617061



### 1-GANG USB OUTLET (1XUSB), WITHOUT FRAME

10 pcs. IP20 PC

\*Article number \*\* EAN code (V)



White



Ivory



Metallic



Champagne



Brown



Anthracite

* USB ww	USB iv	USB mt	USB ch	USB br	USB an
** 4779101630886	4779101631883	4779101639889	4779101636604	4779101633887	4779101637885



### 2-GANG USB OUTLET (2XUSB), WITHOUT FRAME

10 pcs. IP20 PC

\*Article number \*\* EAN code (V)



White



Ivory



Metallic



Champagne



Brown



Anthracite

* USB/USB ww	USB/USB iv	USB/USB mt	USB/USB ch	USB/USB br	USB/USB an
** 4779101630893	4779101631890	4779101639896	4779101636611	4779101633894	4779101637892

# EXPRESS XP 500

## USB AND HDMI OUTLETS · TV SOCKET OUTLETS



### HDMI AND USB OUTLET (HDMI+USB), WITHOUT FRAME

10 pcs. IP20 PC

\*Article number \*\* EAN code (V)

White	Ivory	Metallic	Champagne	Brown	Anthracite
* HDMI/USB ww	HDMI/USB iv	HDMI/USB mt	HDMI/USB ch	HDMI/USB br	HDMI/USB an
** 4779101630909	4779101631906	4779101639902	4779101636628	4779101633900	4779101637908



### 2-GANG USB OUTLET (2XUSB 3,4A), WITHOUT FRAME

10 pcs. IP20 PC

\*Article number \*\* EAN code (V)

White	Ivory	Metallic	Champagne	Brown	Anthracite	Black
* USB-3,4A-02 ww	USB-3,4A-02 iv	USB-3,4A-02 mt	USB-3,4A-02 ch	USB-3,4A-02 br	USB-3,4A-02 an	USB-3,4A-02 blc
** 4779101610536	4779101610543	4779101610550	4779101610574	4779101610581	4779101610871	4779101610598



### TV SOCKET OUTLET, ENDING, WITHOUT FRAME

10 pcs. IP20 PC

\*Article number \*\* EAN code (V)

White	Ivory	Metallic	Champagne	Brown	Anthracite	Black
* TVL01-02 ww	TVL01-02 iv	TVL01-02 mt	TVL01-02 ch	TVL01-02 br	TVL01-02 an	TVL01-02 blc
** 4779101630701	4779101631708	4779101639780	4779101636727	4779101633153	4779101617153	4779101636819



### SAT SOCKET OUTLET, ENDING, WITHOUT FRAME

10 pcs. IP20 PC

\*Article number \*\* EAN code (V)

White	Ivory	Metallic	Champagne	Brown	Anthracite
* SAT01-02 ww	TSAT01-02 iv	SAT01-02 mt	SAT01-02 ch	SAT01-02 br	SAT01-02 an
** 4779101630114	4779101639100	4779101639711	4779101636895	4779101633269	4779101617214



### TV+R SOCKET OUTLET, ENDING, WITHOUT FRAME

10 pcs. IP20 PC

\*Article number \*\* EAN code (V)

White	Ivory	Metallic	Champagne	Brown	Anthracite
* TVL02-02 ww	TVL02-02 iv	TVL02-02 mt	TVL02-02 ch	TVL02-02 br	TVL02-02 an
** 4779101630633	4779101631630	4779101639711	4779101636659	4779101633085	4779101617085

# EXPRESS XP 500

## TV SOCKET OUTLETS · LOUDSPEAKER OUTLETS · BELL



### TV+R+SAT SOCKET OUTLET, ENDING, WITHOUT FRAME

10 pcs. IP20 PC

\*Article number \*\* EAN code (V)



White



Ivory



Metallic



Champagne



Brown



Anthracite



Black

\* TVL03-02 ww

TVL03-02 iv

TVL03-02 mt

TVL03-02 ch

TVL03-02 br

TVL03-02 an

TVL03-02 blc

\*\* 4779101630688

4779101631685

4779101639766

4779101636703

4779101633139

4779101617139

4779101636833



### TV+DATA OUTLET (TV+RJ45), WITHOUT FRAME

10 pcs. IP20 PC

\*Article number \*\* EAN code (V)



White



Ivory



Metallic



Champagne



Brown



Anthracite



Black

\* TVL/KLRJ45-15e2-02 ww TVL/KLRJ45-15e2-02 iv TVL/KLRJ45-15e2-02 mt TVL/KLRJ45-15e2-02 ch TVL/KLRJ45-15e2-02 br TVL/KLRJ45-15e2-02 an TVL/KLRJ45-15e2-02 blc

\*\* 4779101630800

4779101631807

4779101639629

4779101636741

4779101633191

4779101617177

4779101636802



### SAT+DATA OUTLET (SAT+RJ45), WITHOUT FRAME

10 pcs. IP20 PC

\*Article number \*\* EAN code (V)



White



Ivory



Metallic



Champagne



Brown



Anthracite

\* SAT/KLRJ45-15e2-02 ww SAT/KLRJ45-15e2-02 iv SAT/KLRJ45-15e2-02 mt SAT/KLRJ45-15e2-02 ch SAT/KLRJ45-15e2-02 br SAT/KLRJ45-15e2-02 an

\*\* 4779101630107

4779101631111

4779101639148

4779101636949

4779101633276

4779101617221



### 4-GANG LOUDSPEAKER OUTLET, WITHOUT FRAME

10 pcs. IP20 PC

\*Article number \*\* EAN code (V)



White



Ivory



Metallic



Champagne



Brown



Anthracite



Black

\* GL04-02 ww

GL04-02 iv

GL04-02 mt

GL04-02 ch

GL04-02 br

GL04-02 an

GL04-02 blc

\*\* 4779101630480

4779101631333

4779101639827

4779101636871

4779101633177

4779101617191

4779101636888



### BELL, WITHOUT FRAME

10 pcs. IP20 PC

\*Article number \*\* EAN code (V)



White



Ivory



Metallic



Champagne



Brown



Anthracite



Black

\* ES-1 ww

ES-1 iv

ES-1 mt

ES-1 ch

ES-1 br

ES-1 an

ES-1 blc

\*\* 4779101610604

4779101610611

4779101610628

4779101610659

4779101610666

4779101610642

4779101610673

# EXPRESS XP 500

## FRAMES



### 1-GANG FRAME

40 pcs. PC

\*Article number \*\* EAN code (V)

White	Ivory	Metallic	Champagne	Brown	Anthracite
* R01 ww	R01 iv	R01 mt	R01 ch	R01 br	R01 an
** 4779101510287	4779101511284	4779101519297	4779101516555	4779101513011	4779101517019

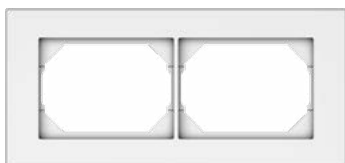

### 2-GANG FRAME

20 pcs. PC

\*Article number \*\* EAN code (V)

White	Ivory	Metallic	Champagne	Brown	Anthracite
* R02 ww	R02 iv	R02 mt	R02 ch	R02 br	R02 an
** 4779101510294	4779101511291	4779101519303	4779101516562	4779101513028	4779101517026

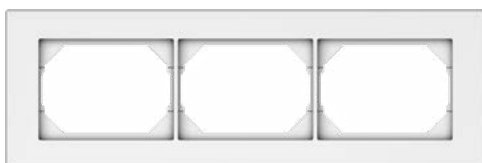

### 3-GANG FRAME

15 pcs. PC

\*Article number \*\* EAN code (V)

White	Ivory	Metallic	Champagne	Brown	Anthracite
* R03 ww	R03 iv	R03 mt	R03 ch	R03 br	R03 an
** 4779101510300	4779101511307	4779101519310	4779101516579	4779101513035	4779101517033

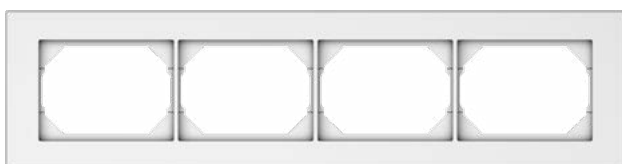

### 4-GANG FRAME

10 pcs. PC

\*Article number \*\* EAN code (V)

White	Ivory	Metallic	Champagne	Brown	Anthracite
* R04 ww	R04 iv	R04 mt	R04 ch	R04 br	R04 an
** 4779101510317	4779101511314	4779101519327	4779101516586	4779101513042	4779101517040

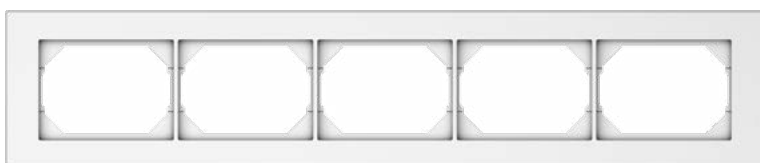

### 5-GANG FRAME

10 pcs. PC

\*Article number \*\* EAN code (V)

White	Ivory	Metallic	Champagne	Brown	Anthracite
* R05 ww	R05 iv	R05 mt	R05 ch	R05 br	R05 an
** 4779101510324	4779101511321	4779101519334	4779101516593	4779101513059	4779101517057

# EXPRESS XP 500

## FRAMES · ACCESSORIES



### 2-GANG VERTICAL FRAME

20 pcs. PC

\*Article number \*\* EAN code (V)



White



Ivory



Metallic



Champagne



Brown



Anthracite

\* RV02 ww

RV02 iv

RV02 mt

RV02 ch

RV02 br

RV02 an

\*\* 4779101510331

4779101511338

4779101519280

4779101516609

4779101513066

4779101517064



### 3-GANG VERTICAL FRAME

10 pcs. PC

\*Article number \*\* EAN code (V)



White



Ivory



Metallic



Champagne



Brown



Anthracite

\* RV03 ww

RV03 iv

RV03 mt

RV03 ch

RV03 br

RV03 an

\*\* 4779101510393

4779101511390

4779101519341

4779101516616

4779101513073

4779101517071



### MOUNTING PLATE FOR 1XRJ SOCKET WITH COVER PLATE, WITHOUT FRAME

30 pcs. PC

\*Article number \*\* EAN code (V)



White



Ivory



Metallic



Champagne



Brown



Anthracite

\* KLRJ45-1 ww

KLRJ45-1 iv

KLRJ45-1 mt

KLRJ45-1 ch

KLRJ45-1 br

KLRJ45-1 an

\*\* 4779101700114

4779101701074

4779101709117

4779101706024

4779101703030

4779101707014



### MOUNTING PLATE FOR 2XRJ SOCKET WITH COVER PLATE, WITHOUT FRAME

30 pcs. PC

\*Article number \*\* EAN code (V)



White



Ivory



Metallic



Champagne



Brown



Anthracite

\* KLRJ45-2 ww

KLRJ45-2 iv

KLRJ45-2 mt

KLRJ45-2 ch

KLRJ45-2 br

KLRJ45-2 an

\*\* 4779101700121

4779101701081

4779101709124

4779101706031

4779101703047

4779101707021



# EXPRESS XP 500

## ACCESSORIES



### TV+R COVER PLATE, WITHOUT FRAME

30 pcs. PC

\*Article number \*\* EAN code (V)



White



Ivory



Metallic



Champagne



Brown



Anthracite

\* TVA02 ww

TVA02 iv

TVA02 mt

TVA02 ch

TVA02 br

TVA02 an

\*\* 4779101700138

4779101701111

4779101709131

4779101706000

4779101703016

4779101707038



### TV+R+SAT COVER PLATE, WITHOUT FRAME

30 pcs. PC

\*Article number \*\* EAN code (V)



White



Ivory



Metallic



Champagne



Brown



Anthracite

\* TVA03 ww

TVA03 iv

TVA03 mt

TVA03 ch

TVA03 br

VA03 an

\*\* 4779101700145

4779101701128

4779101709148

4779101706017

4779101703023

4779101707045

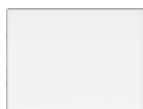

### COVER PLATE

40 pcs. PC

\*Article number \*\* EAN code (V)



White



Ivory



Metallic



Champagne



Brown



Anthracite

\* AD ww

AD iv

AD mt

AD ch

AD br

AD an

\*\* 4779101710021

4779101711028

4779101719024

4779101716030

4779101713022

4779101717020



# EXPRESS XP 500

## GLASS, WOODEN AND STEEL FRAMES

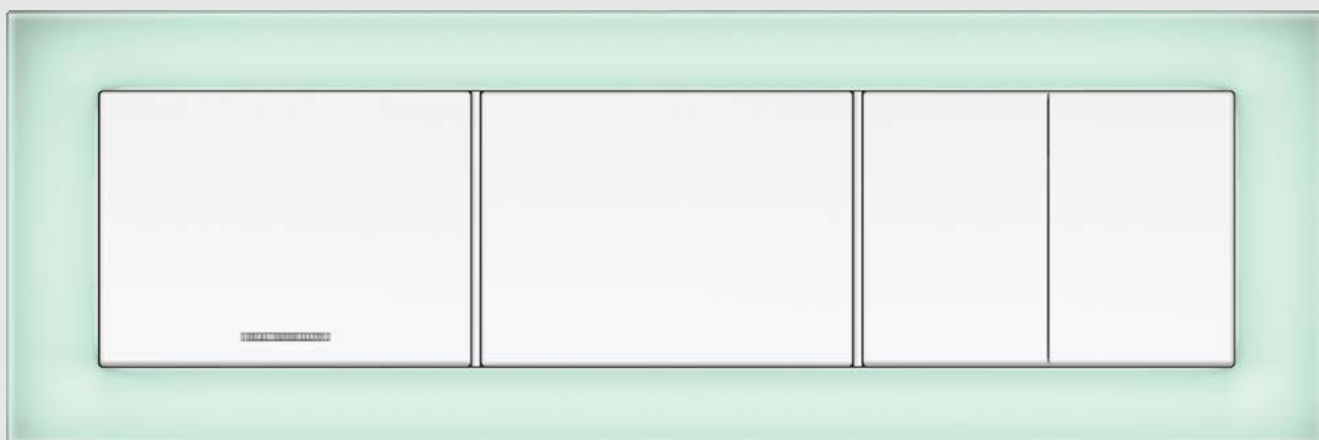

EXPRESS XP 500 product line offers a wide selection of glass and wooden frames. Glass frames are made from hardened glass. The white and green frames have a matte finish to help them blend gently into the surroundings; the black glass product has a gloss finish which gives the product a distinctive elegance.

What makes the wooden frames so striking is their wide range of colours. You can choose the light tone of bleached oak, the more natural beech or oak colours, or the clear and darker shades of walnut, redwood or stained oak. The wooden frames are made from natural wood, making them durable and pleasant to touch.

All these frames can be matched to EXPRESS XP 500 mechanisms of six different colours, thereby creating a distinctive interior in your chosen space. Because of its distinctive elongated form, the frame is all-in-one, seamless, and it gives the product elegance and purity.

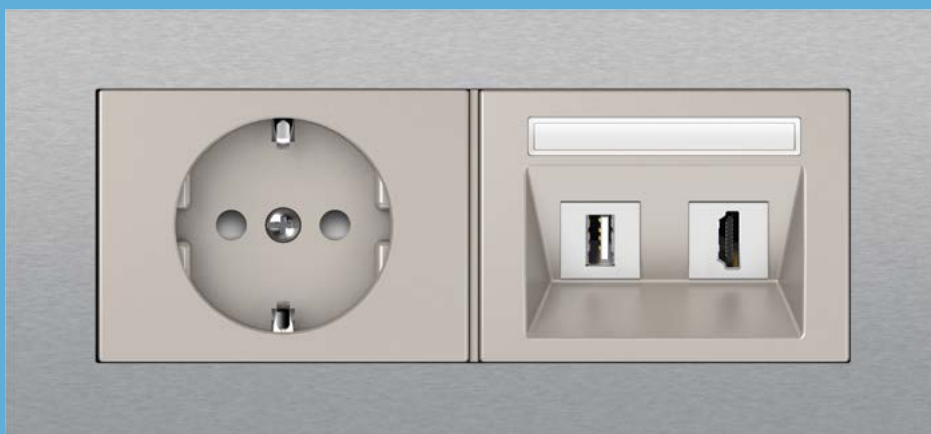
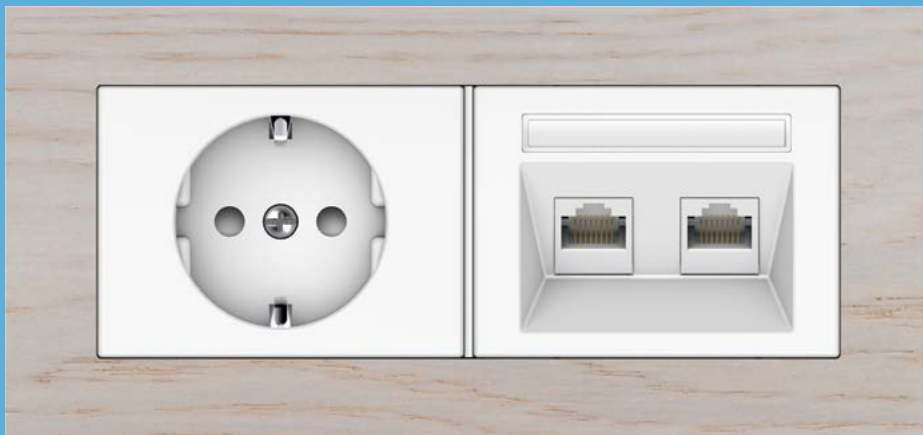

# EXPRESS XP 500

## GLASS FRAMES

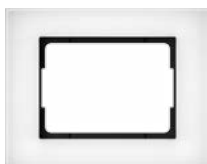

### 1-GANG FRAME FROSTED WHITE GLASS

Article number R01 gmw  
EAN code (V) 4779101518061

8 pcs. Glass



### 2-GANG FRAME FROSTED WHITE GLASS

Article number R02 gmw  
EAN code (V) 4779101518078

4 pcs. Glass

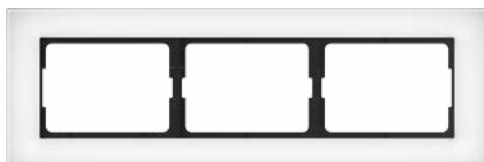

### 3-GANG FRAME FROSTED WHITE GLASS

Article number R03 gmw  
EAN code (V) 4779101518085

4 pcs.  
 Glass



### 4-GANG FRAME FROSTED WHITE GLASS

Article number R04 gmw  
EAN code (V) 4779101518092

4 pcs.  
 Glass



### 5-GANG FRAME FROSTED WHITE GLASS

Article number R05 gmw  
EAN code (V) 4779101518108

4 pcs.  
 Glass



### 1-GANG FRAME FROSTED GREEN GLASS

Article number R01 gmg  
EAN code (V) 4779101518016

8 pcs. Glass



### 2-GANG FRAME FROSTED GREEN GLASS

Article number R02 gmg  
EAN code (V) 4779101518023

4 pcs. Glass

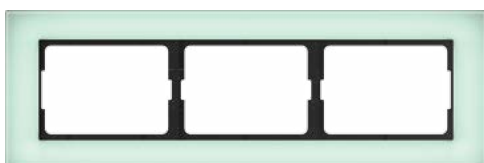

### 3-GANG FRAME FROSTED GREEN GLASS

Article number R03 gmg  
EAN code (V) 4779101518030

4 pcs.  
 Glass



### 4-GANG FRAME FROSTED GREEN GLASS

Article number R04 gmg  
EAN code (V) 4779101518047

4 pcs.  
 Glass



### 5-GANG FRAME FROSTED GREEN GLASS

Article number R05 gmg  
EAN code (V) 4779101518054

4 pcs.  
 Glass

# EXPRESS XP 500

## GLASS AND STEEL FRAMES



### 1-GANG FRAME BLACK GLASS

Article number R01 gcb  
EAN code (V) 4779101518115

8 pcs. Glass



### 2-GANG FRAME BLACK GLASS

Article number R02 gcb  
EAN code (V) 4779101518122

4 pcs. Glass



### 3-GANG FRAME BLACK GLASS

Article number R03 gcb  
EAN code (V) 4779101518139

4 pcs.  
 Glass



### 4-GANG FRAME BLACK GLASS

Article number R04 gcb  
EAN code (V) 4779101518146

4 pcs.  
 Glass



### 5-GANG FRAME BLACK GLASS

Article number R05 gcb  
EAN code (V) 4779101518153

4 pcs.  
 Glass



### 1-GANG FRAME STEEL

Article number R01 stl  
EAN code (V) 4779101516784

30 pcs. Steel

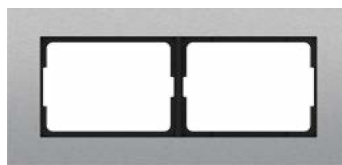

### 2-GANG FRAME STEEL

Article number R02 stl  
EAN code (V) 4779101516791

20 pcs. Steel

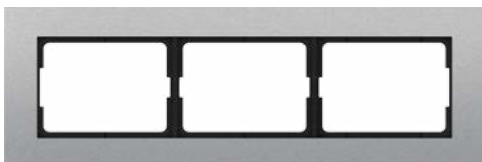

### 3-GANG FRAME STEEL

Article number R03 stl  
EAN code (V) 4779101516807

10 pcs.  
 Steel

# EXPRESS XP 500

## WOODEN FRAMES



### 1-GANG FRAME WHITENED OAK

Article number R01 wwo  
EAN code (V) 4779101516180

8 pcs. Wood



### 2-GANG FRAME WHITENED OAK

Article number R02 wwo  
EAN code (V) 4779101516197

4 pcs. Wood



### 3-GANG FRAME WHITENED OAK

Article number R03 wwo  
EAN code (V) 4779101516203

4 pcs.  
 Wood



### 4-GANG FRAME WHITENED OAK

Article number R04 wwo  
EAN code (V) 4779101516326

4 pcs.  
 Wood



### 5-GANG FRAME WHITENED OAK

Article number R05 wwo  
EAN code (V) 4779101516333

4 pcs.  
 Wood



### 1-GANG FRAME BEECH

Article number R01 wnb  
EAN code (V) 4779101516067

8 pcs. Wood



### 2-GANG FRAME BEECH

Article number R02 wnb  
EAN code (V) 4779101516074

4 pcs. Wood

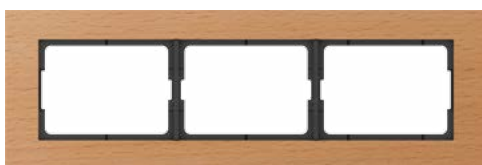

### 3-GANG FRAME BEECH

Article number R03 wnb  
EAN code (V) 4779101516081

4 pcs.  
 Wood

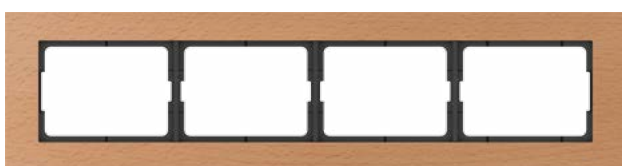

### 4-GANG FRAME BEECH

Article number R04 wnb  
EAN code (V) 4779101516241

4 pcs.  
 Wood

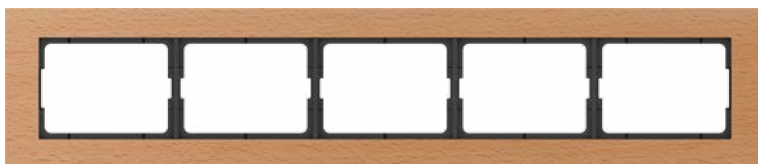

### 5-GANG FRAME BEECH

Article number R05 wnb  
EAN code (V) 4779101516258

4 pcs.  
 Wood

# EXPRESS XP 500

## WOODEN FRAMES

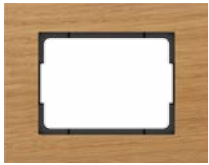

### 1-GANG FRAME OAK

Article number R01 wno  
EAN code (V) 4779101516098

 8 pcs.  Wood



### 2-GANG FRAME OAK



Article number R02 wno  
EAN code (V) 4779101516104

 4 pcs.  Wood



### 3-GANG FRAME OAK



Article number R03 wno  
EAN code (V) 4779101516111

 4 pcs.  
 Wood



### 4-GANG FRAME OAK



Article number R04 wno  
EAN code (V) 4779101516265

 4 pcs.  
 Wood



### 5-GANG FRAME OAK

Article number R05 wno  
EAN code (V) 4779101516272

 4 pcs.  
 Wood



### 1-GANG FRAME WALNUT

Article number R01 wnw  
EAN code (V) 4779101516128

 8 pcs.  Wood



### 2-GANG FRAME WALNUT

Article number R02 wnw  
EAN code (V) 4779101516135

 4 pcs.  Wood



### 3-GANG FRAME WALNUT

Article number R03 wnw  
EAN code (V) 4779101516142

 4 pcs.  
 Wood



### 4-GANG FRAME WALNUT



Article number R04 wnw  
EAN code (V) 4779101516289

 4 pcs.  
 Wood



### 5-GANG FRAME WALNUT

Article number R05 wnw  
EAN code (V) 4779101516296

 4 pcs.  
 Wood



# EXPRESS XP 500

## WOODEN FRAMES



### 1-GANG FRAME MAHOGANY

Article number R01 wnm  
EAN code (V) 4779101516159

8 pcs. Wood



### 2-GANG FRAME MAHOGANY

Article number R02 wnm  
EAN code (V) 4779101516166

4 pcs. Wood



### 3-GANG FRAME MAHOGANY

Article number R03 wnm  
EAN code (V) 4779101516173

4 pcs.  
 Wood



### 4-GANG FRAME MAHOGANY

Article number R04 wnm  
EAN code (V) 4779101516302

4 pcs.  
 Wood



### 5-GANG FRAME MAHOGANY

Article number R05 wnm  
EAN code (V) 4779101516319

4 pcs.  
 Wood



### 1-GANG FRAME DARK OAK

Article number R01 wdo  
EAN code (V) 4779101516210

8 pcs. Wood



### 2-GANG FRAME DARK OAK

Article number R02 wdo  
EAN code (V) 4779101516227

4 pcs. Wood



### 3-GANG FRAME DARK OAK

Article number R03 wdo  
EAN code (V) 4779101516234

4 pcs.  
 Wood



### 4-GANG FRAME DARK OAK

Article number R04 wdo  
EAN code (V) 4779101516340

4 pcs.  
 Wood



### 5-GANG FRAME DARK OAK

Article number R05 wdo  
EAN code (V) 4779101516357

4 pcs.  
 Wood





# LUXE LX 200

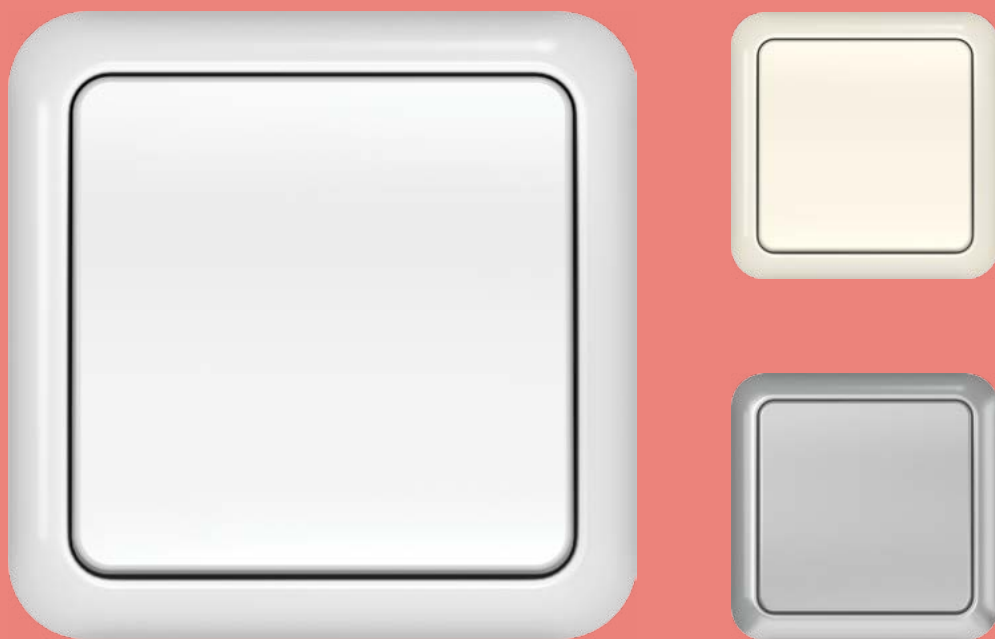

---

**LUXE LX 200** product series stands out for its classic elegance. The true rectangular shape and rounded edges match each other harmoniously, so they are especially suited to a classic interior or a modern interior with gentle classical elements.

# LUXE LX 200

## SWITCHES



### 1-GANG SWITCH, WITHOUT FRAME

10 pcs. 10A, 250V~ IP20 PC

\*Article number \*\* EAN code (V) \*\*\* EAN code (D)



White



Ivory



Metallic

\* P110-010-02 ww P110-010-02 iv P110-010-02 mt

\*\* 4779101210033 4779101211610 4779101219036

\*\*\* 4779101200034



### 1-GANG SWITCH WITH ILLUMINATION, WITHOUT FRAME

10 pcs. 10A, 250V~ IP20 PC

\*Article number \*\* EAN code (V) \*\*\* EAN code (D)



White



Ivory



Metallic

\* P110-010-12 ww P110-010-12 iv P110-010-12 mt

\*\* 4779101210040 4779101211634 4779101219043



### 1-GANG SWITCH (IP44), WITHOUT FRAME

10 pcs. 10A, 250V~ IP44 PC

\*Article number \*\* EAN code (V) \*\*\* EAN code (D)



White



Ivory



Metallic

\* P110-010-04 ww P110-010-04 iv P110-010-04 mt

\*\* 4779101210521 4779101211689 4779101219333



### 1-GANG 2 POLE SWITCH, WITHOUT FRAME

10 pcs. 10A, 250V~ IP20 PC Production by the order

\*Article number \*\* EAN code (V) \*\*\* EAN code (D)



White



Ivory



Metallic

\* P210-010-02 ww P210-010-02 iv P210-010-02 mt

\*\* 4779101210194 4779101211658 4779101219197



### 1-GANG 2 POLE SWITCH WITH ILLUMINATION, WITHOUT FRAME

10 pcs. 10A, 250V~ IP20 PC Production by the order

\*Article number \*\* EAN code (V) \*\*\* EAN code (D)



White



Ivory



Metallic

\* P210-010-12 ww P210-010-12 iv P210-010-12 mt

\*\* 4779101200217 4779101211672 4779101219210

# LUXE LX 200

## SWITCHES



### 1-GANG 2 POLE SWITCH (IP44), WITHOUT FRAME

10 pcs. 10A, 250V~ IP44 PC Production by the order

\*Article number \*\* EAN code (V) \*\*\* EAN code (D)



White



Ivory



Metallic

\* P210-010-04 ww

P210-010-04 iv

P210-010-04 mt

\*\* 4779101210538

4779101211696

4779101219364



### 2-GANG SWITCH, WITHOUT FRAME

10 pcs. 10A, 250V~ IP20 PC

\*Article number \*\* EAN code (V) \*\*\* EAN code (D)



White



Ivory



Metallic

\* P510-020-02 ww

P510-020-02 iv

P510-020-02 mt

\*\* 4779101310030

4779101311181

4779101319033

\*\*\* 4779101300031



### 2-GANG SWITCH WITH ILLUMINATION, WITHOUT FRAME

10 pcs. 10A, 250V~ IP20 PC

\*Article number \*\* EAN code (V) \*\*\* EAN code (D)



White



Ivory



Metallic

\* P510-020-12 ww

P510-020-12 iv

P510-020-12 mt

\*\* 4779101310047

4779101311204

4779101319040



### 2-GANG SWITCH (IP44), WITHOUT FRAME

10 pcs. 10A, 250V~ IP44 PC

\*Article number \*\* EAN code (V) \*\*\* EAN code (D)



White



Ivory



Metallic

\* P510-020-04 ww

P510-020-04 iv

P510-020-04 mt

\*\* 4779101310160

4779101311211

4779101319163



### 3-GANG SWITCH, WITHOUT FRAME

10 pcs. 10A, 250V~ IP20 PC

\*Article number \*\* EAN code (V) \*\*\* EAN code (D)



White



Ivory



Metallic

\* P510-030-02 ww

P510-030-02 iv

P510-030-02 mt

\*\* 4779101210583

4779101211702

4779101219395

# LUXE LX 200

## TWO-WAY SWITCHES



### 1-GANG TWO-WAY SWITCH, WITHOUT FRAME

10 pcs. 10A, 250V~ IP20 PC

\*Article number \*\* EAN code (V) \*\*\* EAN code (D)



White



Ivory



Metallic

* P610-010-02 ww	P610-010-02 iv	P610-010-02 mt
** 4779101410037	4779101411843	4779101419030
*** 4779101400038		



### 1-GANG TWO-WAY SWITCH WITH ILLUMINATION, WITHOUT FRAME

10 pcs. 10A, 250V~ IP20 PC

\*Article number \*\* EAN code (V) \*\*\* EAN code (D)



White



Ivory



Metallic

* P610-010-12 ww	P610-010-12 iv	P610-010-12 mt
** 4779101410044	4779101411867	4779101419047



### 1-GANG TWO-WAY SWITCH (IP44), WITHOUT FRAME

10 pcs. 10A, 250V~ IP44 PC

\*Article number \*\* EAN code (V) \*\*\* EAN code (D)



White



Ivory



Metallic

* P610-010-04 ww	P610-010-04 iv	P610-010-04 mt
** 4779101410730	4779101411997	4779101419702



### 2-GANG TWO-WAY SWITCH, WITHOUT FRAME

10 pcs. 10A, 250V~ IP20 PC

\*Article number \*\* EAN code (V) \*\*\* EAN code (D)



White



Ivory



Metallic

* P(6+6)10-020-02 ww	P(6+6)10-020-02 iv	P(6+6)10-020-02 mt
** 4779101410310	4779101411928	4779101419313



### 2-GANG TWO-WAY SWITCH (IP44), WITHOUT FRAME

10 pcs. 10A, 250V~ IP44 PC

\*Article number \*\* EAN code (V) \*\*\* EAN code (D)



White



Ivory



Metallic

* P(6+6)10-020-04 ww	P(6+6)10-020-04 iv	P(6+6)10-020-04 mt
** 4779101410785	4779101431025	4779101419740

# LUXE LX 200

## TWO-WAY SWITCHES



### 1-GANG INTERMEDIATE SWITCH, WITHOUT FRAME

10 pcs. 10A, 250V~ IP20 PC

\*Article number \*\* EAN code (V) \*\*\* EAN code (D)



White



Ivory



Metallic

* P710-010-02 ww	P710-010-02 iv	P710-010-02 mt
** 4779101410419	4779101411966	4779101419412



### 1-GANG INTERMEDIATE SWITCH WITH ILLUMINATION, WITHOUT FRAME

10 pcs. 10A, 250V~ IP20 PC

\*Article number \*\* EAN code (V) \*\*\* EAN code (D)



White



Ivory



Metallic

* P710-010-12 ww	P710-010-12 iv	P710-010-12 mt
** 4779101410433	4779101411980	4779101419436



### 1-GANG INTERMEDIATE SWITCH (IP44), WITHOUT FRAME

10 pcs. 10A, 250V~ IP44 PC

\*Article number \*\* EAN code (V) \*\*\* EAN code (D)



White



Ivory



Metallic

* P710-010-04 ww	P710-010-04 iv	P710-010-04 mt
** 4779101410754	4779101431018	4779101419726



# LUXE LX 200

## PUSH-BUTTON SWITCHES



### 1-GANG PUSH-BUTTON SWITCH, WITHOUT FRAME

10 pcs. 10A, 250V~ IP20 PC Production by the order

\*Article number \*\* EAN code (V) \*\*\* EAN code (D)



White



Ivory



Metallic

\* P110-012-22 ww

P110-012-22 iv

P110-012-22 mt

\*\* 4779101810097

4779101811384

4779101819069



### 1-GANG PUSH-BUTTON SWITCH WITH ILLUMINATION, WITHOUT FRAME

10 pcs. 10A, 250V~ IP20 PC Production by the order

\*Article number \*\* EAN code (V) \*\*\* EAN code (D)



White



Ivory



Metallic

\* P110-012-32 ww

P110-012-32 iv

P110-012-32 mt

\*\* 4779101810158

4779101811407

4779101819076



### 1-GANG PUSH-BUTTON SWITCH (IP44), WITHOUT FRAME

10 pcs. 10A, 250V~ IP44 PC Production by the order

\*Article number \*\* EAN code (V) \*\*\* EAN code (D)



White



Ivory



Metallic

\* P110-012-24 ww

P110-012-24 iv

P110-012-24 mt

\*\* 4779101810295

4779101811421

4779101819168



### 2-GANG PUSH-BUTTON SWITCH, WITHOUT FRAME

10 pcs. 10A, 250V~ IP20 PC Production by the order

\*Article number \*\* EAN code (V) \*\*\* EAN code (D)



White



Ivory



Metallic

\* P410-020-22 ww

P410-020-22 iv

P410-020-22 mt

\*\* 4779101810103

4779101811391

4779101819038



### 2-GANG PUSH-BUTTON SWITCH WITH ILLUMINATION, WITHOUT FRAME

10 pcs. 10A, 250V~ IP20 PC Production by the order

\*Article number \*\* EAN code (V) \*\*\* EAN code (D)



White



Ivory



Metallic

\* P410-020-32 ww

P410-020-32 iv

P410-020-32 mt

\*\* 4779101810165

4779101811414

4779101819083

# LUXE LX 200

## PUSH-BUTTON SWITCHES · PUSH-BUTTON SWITCHES “BELL”



### 2-GANG PUSH-BUTTON SWITCH (IP44), WITHOUT FRAME

10 pcs. 10A, 250V~ IP44 PC Production by the order

\*Article number \*\* EAN code (V) \*\*\* EAN code (D)



White



Ivory



Metallic

\* P410-020-24 ww

P410-020-24 iv

P410-020-24 mt

\*\* 4779101810332

4779101811483

4779101819182



### 1-GANG PUSH-BUTTON SWITCH “BELL”, WITH FRAME

10 pcs. 10A, 250V~ IP20 PC

\*Article number \*\* EAN code (V) \*\*\* EAN code (D)



White



Ivory



Metallic

\* P110-012 ww

P110-012 iv

P110-012 mt

\*\* 4779101810011

4779101811469

4779101819014



### 1-GANG PUSH-BUTTON SWITCH “BELL” WITH ILLUMINATION, WITH FRAME

10 pcs. 10A, 250V~ IP20 PC

\*Article number \*\* EAN code (V) \*\*\* EAN code (D)



White



Ivory



Metallic

\* P110-012-10 ww

P110-012-10 iv

P110-012-10 mt

\*\* 4779101810028

4779101811377

4779101819021

# LUXE LX 200

## BLINDS SWITCHES - THERMOSTATS



### 2-GANG BLIND SWITCH, WITHOUT FRAME

10 pcs. 10A, 250V~ IP20 PC

\*Article number \*\* EAN code (V) \*\*\* EAN code (D)



White



Ivory



Metallic

\* P410-020-02 ww

P410-020-02 iv

P410-020-02 mt

\*\* 4779101410211

4779101411881

4779101419214



### 2-GANG BLIND SWITCH WITH ILLUMINATION, WITHOUT FRAME

10 pcs. 10A, 250V~ IP20 PC Production by the order

\*Article number \*\* EAN code (V) \*\*\* EAN code (D)



White



Ivory



Metallic

\* P410-020-12 ww

P410-020-12 iv

P410-020-12 mt

\*\* 4779101410235

4779101411904

4779101419238



### 2-GANG BLIND SWITCH (IP44), WITHOUT FRAME

10 pcs. 10A, 250V~ IP44 PC Production by the order

\*Article number \*\* EAN code (V) \*\*\* EAN code (D)



White



Ivory



Metallic

\* P410-020-04 ww

P410-020-04 iv

P410-020-04 mt

\*\* 4779101410815

4779101431032

4779101419764



### ROOM THERMOSTAT, WITHOUT FRAME

4 pcs. 230V~, 50Hz IP20 PC Production by the order

\*Article number \*\* EAN code (V) \*\*\* EAN code (D)



White



Ivory



Metallic

\* Fre R2A ww

Fre R2A iv

Fre R2A mt

\*\* 4779101910780

4779101911893

4779101919721



### FLOOR THERMOSTAT, WITHOUT FRAME

4 pcs. 230V~, 50Hz IP20 PC Production by the order

\*Article number \*\* EAN code (V) \*\*\* EAN code (D)



White



Ivory



Metallic

\* FRe F2A ww

FRe F2A iv

FRe F2A mt

\*\* 4779101910568

4779101911664

4779101919554

# LUXE LX 200

## DIMMERS



### ROTARY DIMMER (20-400 W) OF LIGHT BULBS AND HV HALOGEN LAMPS, WITH FRAME

6 pcs. ⚡ 250V~, 50Hz IP20 PC

\*Article number \*\* EAN code (V) \*\*\* EAN code (D)



White



Ivory



Metallic

* ARMPM400 ww	ARMPM400 iv	ARMPM400 mt
** 4779101910513	4779101911640	4779101919516

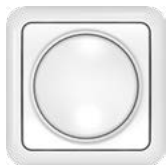

### ROTARY DIMMER (40-600 W) OF LIGHT BULBS AND HV HALOGEN LAMPS, WITH FRAME

6 pcs. ⚡ 250V~, 50Hz IP20 PC

\*Article number \*\* EAN code (V) \*\*\* EAN code (D)



White



Ivory



Metallic

* ARMPM600 ww	ARMPM600 iv	ARMPM600 mt
** 4779101910520	4779101911657	4779101919523



### ROTARY DIMMER (1-100 W) OF LED DIMMABLE LAMPS, WITH FRAME

6 pcs. ⚡ 250V~, 50Hz IP20 PC

\*Article number \*\* EAN code (V) \*\*\* EAN code (D)



White



Ivory



Metallic

* ARMP LED ww	ARMP LED iv	ARMP LED mt
** 4779101910599	4779101911671	4779101913585

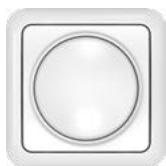

### ROTARY DIMMER (1-200 W) OF LED DIMMABLE LAMPS, WITH FRAME

6 pcs. ⚡ 250V~, 50Hz IP20 PC

\*Article number \*\* EAN code (V) \*\*\* EAN code (D)



White



Ivory



Metallic

* ARMPLED1-200 iv	ARMPLED1-200 mt	ARMPLED1-200 mt
** 477910111687	477910111688	477910111689

# LUXE LX 200

## SOCKET OUTLETS



### SOCKET OUTLET, WITHOUT FRAME

10 pcs. 16A, 250V~ IP20 PC

\*Article number \*\* EAN code (V) \*\*\* EAN code (D)



White



Ivory



Metallic

\* RP16-001-02 ww RP16-001-02 iv RP16-001-02 mt

\*\* 4779101110128 4779101111675 4779101119121

\*\*\* 4779101100129



### SOCKET OUTLET WITH SHUTTERS, WITHOUT FRAME

10 pcs. 16A, 250V~ IP20 PC

\*Article number \*\* EAN code (V) \*\*\* EAN code (D)



White



Ivory



Metallic

\* RP16-001-22 ww RP16-001-22 iv RP16-001-22 mt

\*\* 4779101110302 4779101111736 4779101119305



### SCHUKO SOCKET OUTLET, WITHOUT FRAME

10 pcs. 16A, 250V~ IP20 PC

\*Article number \*\* EAN code (V) \*\*\* EAN code (D)



White



Ivory



Metallic

\* RP16-002-02 ww RP16-002-02 iv RP16-002-02 mt

\*\* 4779101110142 4779101111699 4779101119145

\*\*\* 4779101100143



### SCHUKO SOCKET OUTLET WITH SHUTTERS, WITHOUT FRAME

10 pcs. 16A, 250V~ IP20 PC

\*Article number \*\* EAN code (V) \*\*\* EAN code (D)



White



Ivory



Metallic

\* RP16-002-22 ww RP16-002-22 iv RP16-002-22 mt

\*\* 4779101110326 4779101111750 4779101119329



### SCHUKO SOCKET OUTLET WITH HINGED LID (IP44), WITHOUT FRAME

10 pcs. 16A, 250V~ IP44 PC

\*Article number \*\* EAN code (V) \*\*\* EAN code (D)



White



Ivory



Metallic

\* RP16-003-02 ww RP16-003-02 iv RP16-003-02 mt

\*\* 4779101110241 4779101111712 4779101119244

# LUXE LX 200

## SOCKET OUTLETS · TELEPHONE AND DATA OUTLETS



### SCHUKO SOCKET OUTLET WITH HINGED LID WITH SHUTTERS (IP44), WITHOUT FRAME

10 stk. ⚡ 16A, 250V~ IP44 PC

\*Article number \*\* EAN code (V)



White



Ivory



Metallic

* RP16-003-22 ww	RP16-003-22 iv	RP16-003-22 mt
** 477910111690	477910111691	477910111692



### 1-GANG TELEPHONE OUTLET (1XRJ11 CAT3E), WITHOUT FRAME

10 pcs. IP20 PC

\*Article number \*\* EAN code (V) \*\*\* EAN code (D)



White



Ivory



Metallic

* TLRJ11-131-02 ww	TLRJ11-131-02 iv	TLRJ11-131-02 mt
** 4779101630411	4779101611700	4779101639414



### 2-GANG TELEPHONE OUTLET (2XRJ11 CAT3E), WITHOUT FRAME

10 pcs. IP20 PC Production by the order

\*Article number \*\* EAN code (V) \*\*\* EAN code (D)



White



Ivory



Metallic

* TLRJ11-231-02 ww	TLRJ11-231-02 iv	TLRJ11-231-02 mt
** 4779101630435	4779101611724	4779101639162



### TELEPHONE AND DATA OUTLET (RJ11XRJ45 CAT3XCAT5E UTP), WITHOUT FRAME

10 pcs. IP20 PC

\*Article number \*\* EAN code (V) \*\*\* EAN code (D)



White



Ivory



Metallic

* TKLRJ35e2-02 ww	TKLRJ35e2-02 iv	TKLRJ35e2-02 mt
** 4779101630510	4779101611816	4779101639513



### 1-GANG DATA OUTLET (1XRJ45 CAT5E UTP), WITHOUT FRAME

10 pcs. IP20 PC

\*Article number \*\* EAN code (V) \*\*\* EAN code (D)



White



Ivory



Metallic

* KLRJ45-15e2-02 ww	KLRJ45-15e2-02 iv	KLRJ45-15e2-02 mt
** 4779101630282	4779101611748	4779101639285

# LUXE LX 200

## TELEPHONE AND DATA OUTLETS



### 2-GANG DATA OUTLET (2XRJ45 CAT5E UTP), WITHOUT FRAME

10 pcs. IP20 PC

\*Article number \*\* EAN code (V) \*\*\* EAN code (D)



White



Ivory



Metallic

\* KLRJ45-25e2-02 ww KLRJ45-25e2-02 iv KLRJ45-25e2-02 mt

\*\* 4779101630329 4779101611762 4779101639322



### 1-GANG DATA OUTLET (1XRJ45 CAT5E UTP AMP), WITHOUT FRAME

10 pcs. IP20 PC Production by the order

\*Article number \*\* EAN code (V) \*\*\* EAN code (D)



White



Ivory



Metallic

\* KLRJ45-15e1-02 ww KLRJ45-15e1-02 iv KLRJ45-15e1-02 mt

\*\* 4779101630206 4779101631999 4779101639209



### 2-GANG DATA OUTLET (2XRJ45 CAT5E UTP AMP), WITHOUT FRAME

10 pcs. IP20 PC Production by the order

\*Article number \*\* EAN code (V) \*\*\* EAN code (D)



White



Ivory



Metallic

\* KLRJ45-25e1-02 ww KLRJ45-25e1-02 iv KLRJ45-25e1-02 mt

\*\* 4779101630008 4779101611687 4779101639001

# LUXE LX 200

## TELEPHONE AND DATA OUTLETS · TV SOCKET OUTLETS



### TV SOCKET OUTLET, ENDING, WITHOUT FRAME

10 pcs. IP20 PC

\*Article number \*\* EAN code (V) \*\*\* EAN code (D)



White



Ivory



Metallic

* TVL01-02 ww	TVL01-02 iv	TVL01-02 mt
** 4779101630732	4779101611823	4779101639537



### SAT SOCKET OUTLET, ENDING, WITHOUT FRAME

10 pcs. IP20 PC

\*Article number \*\* EAN code (V) \*\*\* EAN code (D)



White



Ivory



Metallic

* SAT01-02 ww	SAT01-02 iv	SAT01-02 mt
** 4779101630152	4779101611137	4779101639155



### TV+R SOCKET OUTLET, ENDING, WITHOUT FRAME

10 pcs. IP20 PC

\*Article number \*\* EAN code (V) \*\*\* EAN code (D)



White



Ivory



Metallic

* TVL02-02 ww	TVL02-02 iv	TVL02-02 mt
** 4779101610147	4779101611564	4779101619157



### TV+R+SAT SOCKET OUTLET, ENDING, WITHOUT FRAME

10 pcs. IP20 PC

\*Article number \*\* EAN code (V) \*\*\* EAN code (D)



White



Ivory



Metallic

* TVL03-02 ww	TVL03-02 iv	TVL03-02 mt
** 4779101610222	4779101611908	4779101619232



### TV+DATA OUTLET (TVXRJ45), WITHOUT FRAME

10 pcs. IP20 PC

\*Article number \*\* EAN code (V) \*\*\* EAN code (D)



White



Ivory



Metallic

* TVL/KLRJ45-15e2-02 ww	TVL/KLRJ45-15e2-02 iv	TVL/KLRJ45-15e2-02 mt
** 4779101630794	4779101611847	4779101639575



# LUXE LX 200

## TV SOCKET OUTLETS · LOUDSPEAKER OUTLETS



### SAT+DATA OUTLET (SAT+RJ45), WITHOUT FRAME

10 pcs. IP20 PC

\*Article number \*\* EAN code (V) \*\*\* EAN code (D)



White



Ivory



Metallic

\* SAT/KLRJ45-15E2-02 ww SAT/KLRJ45-15E2-02 iv SAT/KLRJ45-15E2-02 mt

\*\* 4779101630220 4779101611151 4779101639186



### 4-GANG LOUDSPEAKER OUTLET, WITHOUT FRAME

10 pcs. IP20 PC

\*Article number \*\* EAN code (V) \*\*\* EAN code (D)



White



Ivory



Metallic

\* GL04-02 ww GL04-02 iv GL04-02 mt

\*\* 4779101630145 4779101611809 4779101639841

# LUXE LX 200

## FRAMES



### 1-GANG FRAME

60 pcs. PC

\*Article number \*\* EAN code (V) \*\*\* EAN code (D)



White



Ivory



Metallic

\* R01 ww

R01 iv

R01 mt

\*\* 4779101510010

4779101511406

4779101519013



### 2-GANG FRAME

30 pcs. PC

\*Article number \*\* EAN code (V) \*\*\* EAN code (D)



White



Ivory



Metallic

\* R02 ww

R02 iv

R02 mt

\*\* 4779101510027

4779101511413

4779101519020

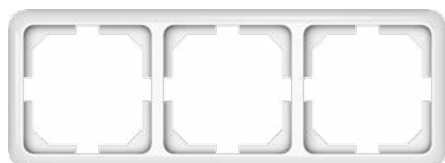

### 3-GANG FRAME

20 pcs. PC

\*Article number \*\* EAN code (V) \*\*\* EAN code (D)



White



Ivory



Metallic

\* R03 ww

R03 iv

R03 mt

\*\* 4779101510034

4779101511420

4779101519037

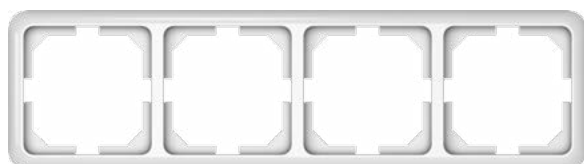

### 4-GANG FRAME

10 pcs. PC

\*Article number \*\* EAN code (V) \*\*\* EAN code (D)



White



Ivory



Metallic

\* R04 ww

R04 iv

R04 mt

\*\* 4779101510041

4779101511437

4779101519044

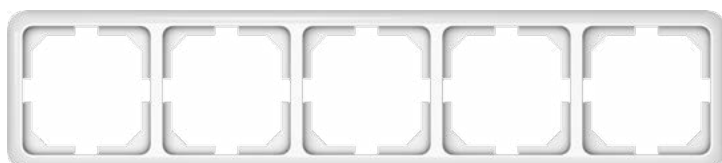

### 5-GANG FRAME

10 pcs. PC

\*Article number \*\* EAN code (V) \*\*\* EAN code (D)



White



Ivory



Metallic

\* R05 ww

R05 iv

R05 mt

\*\* 4779101510072

4779101511444

4779101519075

# LUXE LX 200

## ACCESSORIES



### MOUNTING PLATE FOR 1XRJ SOCKET WITH COVER PLATE, WITHOUT FRAME

30 pcs. PC

\*Article number \*\* EAN code (V) \*\*\* EAN code (D)



White



Ivory



Metallic

\* KLRJ45-1 ww

KLRJ45-1 iv

KLRJ45-1 mt

\*\* 4779101700046

4779101701036

4779101709049



### MOUNTING PLATE FOR 2XRJ SOCKET WITH COVER PLATE, WITHOUT FRAME

30 pcs. PC

\*Article number \*\* EAN code (V) \*\*\* EAN code (D)



White



Ivory



Metallic

\* KLRJ45-2 ww

KLRJ45-2 iv

KLRJ45-2 mt

\*\* 4779101700053

4779101701210

4779101709056

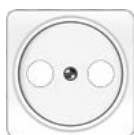

### TV+R COVER PLATE, WITHOUT FRAME

30 pcs. PC

\*Article number \*\* EAN code (V) \*\*\* EAN code (D)



White



Ivory



Metallic

\* TVA02 ww

TVA02 iv

TVA02 mt

\*\* 4779101700091

4779101701043

4779101709094



### TV+R+SAT COVER PLATE, WITHOUT FRAME

30 pcs. PC

\*Article number \*\* EAN code (V) \*\*\* EAN code (D)



White



Ivory



Metallic

\* TVA03 ww

TVA03 iv

TVA03 mt

\*\* 4779101700107

4779101701142

4779101709100



### COVER PLATE

40 pcs. PC

\*Article number \*\* EAN code (V) \*\*\* EAN code (D)



White



Ivory



Metallic

\* AD ww

AD iv

AD mt

\*\* 779101710014

4779101711042

4779101719017



# SPECTRUM SP 300

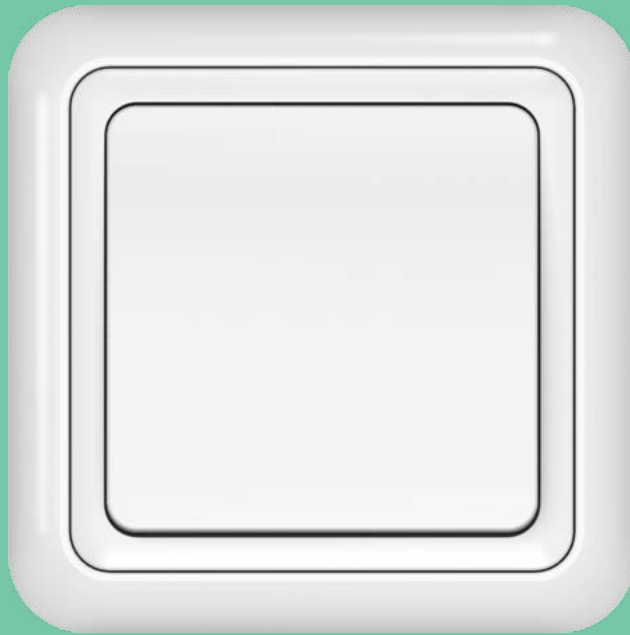

**SPECTRUM SP 300** product series, with a stylised inner frame that delicately matches the outer frame, gives the interior subtlety. The products in this series will appeal to those who are keen on accenting details and searching the surroundings for more varied forms.



# SPECTRUM SP 300

## SWITCHES



### 1-GANG SWITCH, WITHOUT FRAME

10 pcs. 10A, 250V~ IP20 PC

\*Article number \*\* EAN code (V)



White



Ivory



Anthracite

\* P110-010-02 ww

P110-010-02 iv

P110-010-02 an

\*\* 4779101210361

4779101211368

4779101217360



### 1-GANG SWITCH WITH ILLUMINATION, WITHOUT FRAME

10 pcs. 10A, 250V~ IP20 PC

\*Article number \*\* EAN code (V)



White



Ivory



Anthracite

\* P110-010-12 ww

P110-010-12 iv

P110-010-12 an

\*\* 4779101210385

4779101211382

4779101217384



### 1-GANG 2 POLE SWITCH, WITHOUT FRAME

10 pcs. 10A, 250V~ IP20 PC Production by the order

\*Article number \*\* EAN code (V)



White



Ivory



Anthracite

\* P210-010-02 ww

P210-010-02 iv

P210-010-02 an

\*\* 4779101210484

4779101211481

4779101217483



### 1-GANG 2 POLE SWITCH WITH ILLUMINATION, WITHOUT FRAME

10 pcs. 10A, 250V~ IP20 PC Production by the order

\*Article number \*\* EAN code (V)



White



Ivory



Anthracite

\* P210-010-12 ww

P210-010-12 iv

P210-010-12 an

\*\* 4779101210507

4779101211504

4779101217506



### 2-GANG SWITCH, WITHOUT FRAME

10 pcs. 10A, 250V~ IP20 PC

\*Article number \*\* EAN code (V)



White



Ivory



Anthracite

\* P510-020-02 ww

P510-020-02 iv

P510-020-02 an

\*\* 4779101210408

4779101211405

4779101217407

# SPECTRUM SP 300

## SWITCHES · TWO-WAY SWITCHES



### 2-GANG SWITCH WITH ILLUMINATION, WITHOUT FRAME

10 pcs. 10A, 250V~ IP20 PC

\*Article number \*\* EAN code (V)



White



Ivory



Anthracite

\* P510-020-12 ww

P510-020-12 iv

P510-020-12 an

\*\* 4779101210422

4779101211429

4779101217421



### 1-GANG TWO-WAY SWITCH, WITHOUT FRAME

10 pcs. 10A, 250V~ IP20 PC

\*Article number \*\* EAN code (V)



White



Ivory



Anthracite

\* P610-010-02 ww

P610-010-02 iv

P610-010-02 an

\*\* 4779101210446

4779101211443

4779101217445



### 1-GANG TWO-WAY SWITCH WITH ILLUMINATION, WITHOUT FRAME

10 pcs. 10A, 250V~ IP20 PC

\*Article number \*\* EAN code (V)



White



Ivory



Anthracite

\* P610-010-12 ww

P610-010-12 iv

P610-010-12 an

\*\* 4779101210460

4779101211467

4779101217469



### 2-GANG TWO-WAY SWITCH, WITHOUT FRAME

10 pcs. 10A, 250V~ IP20 PC

\*Article number \*\* EAN code (V)



White



Ivory



Anthracite

\* P(6+6)10-020-02 ww P(6+6)10-020-02 iv P(6+6)10-020-02 an

\*\* 4779101410686

4779101411683

4779101417685



### 1-GANG INTERMEDIATE SWITCH, WITHOUT FRAME

10 pcs. 10A, 250V~ IP20 PC

\*Article number \*\* EAN code (V)



White



Ivory



Anthracite

\* P710-010-02 ww

P710-010-02 iv

P710-010-02 an

\*\* 4779101410648

4779101411645

4779101417647



# SPECTRUM SP 300

## TWO-WAY SWITCHES · PUSH-BUTTON SWITCHES



### 1-GANG INTERMEDIATE SWITCH WITH ILLUMINATION, WITHOUT FRAME

10 pcs. 10A, 250V~ IP20 PC

\*Article number \*\* EAN code (V)



White



Ivory



Anthracite

\* P710-010-12 ww

P710-010-12 iv

P710-010-12 an

\*\* 4779101410662

4779101411669

4779101417661



### 1-GANG PUSH-BUTTON SWITCH, WITHOUT FRAME

10 pcs. 10A, 250V~ IP20 PC Production by the order

\*Article number \*\* EAN code (V)



White



Ivory



Anthracite

\* P110-012-22 ww

P110-012-22 iv

P110-012-22 an

\*\* 4779101810134

4779101811148

4779101817119



### 1-GANG PUSH-BUTTON SWITCH WITH ILLUMINATION, WITHOUT FRAME

10 pcs. 10A, 250V~ IP20 PC Production by the order

\*Article number \*\* EAN code (V)



White



Ivory



Anthracite

\* P110-012-32 ww

P110-012-32 iv

P110-012-32 an

\*\* 4779101810196

4779101811209

4779101817157



### 2-GANG PUSH-BUTTON SWITCH, WITHOUT FRAME

10 pcs. 10A, 250V~ IP20 PC Production by the order

\*Article number \*\* EAN code (V)



White



Ivory



Anthracite

\* P410-020-22 ww

P410-020-22 iv

P410-020-22 an

\*\* 4779101810141

4779101811155

4779101817126



### 2-GANG PUSH-BUTTON SWITCH WITH ILLUMINATION, WITHOUT FRAME

10 pcs. 10A, 250V~ IP20 PC Production by the order

\*Article number \*\* EAN code (V)



White



Ivory



Anthracite

\* P410-020-32 ww

P410-020-32 iv

P410-020-32 an

\*\* 4779101810202

4779101811216

4779101817164

# SPECTRUM SP 300

## PUSH-BUTTON SWITCHES · PUSH-BUTTON SWITCHES “BELL”



### 1-GANG PUSH-BUTTON SWITCH “BELL”, WITH FRAME

10 pcs. 10A, 250V~ IP20 PC

\*Article number \*\* EAN code (V)



White



Ivory



Anthracite

\* P110-012 ww

P110-012 iv

P110-012 an

\*\* 4779101810073

4779101811094

4779101817072



### 1-GANG PUSH-BUTTON SWITCH “BELL” WITH ILLUMINATION, WITH FRAME

10 pcs. 10A, 250V~ IP20 PC Production by the order

\*Article number \*\* EAN code (V)



White



Ivory



Anthracite

\* P110-012-10 ww

P110-012-10 iv

P110-012-10 an

\*\* 4779101810080

4779101811087

4779101817089

# SPECTRUM SP 300

## BLINDS SWITCHES · DIMMERS AND THERMOSTATS



### 2-GANG BLIND SWITCH, WITHOUT FRAME

10 pcs. 10A, 250V~ IP20 PC

\*Article number \*\* EAN code (V)



White



Ivory



Anthracite

\* P410-020-02 ww

P410-020-02 iv

P410-020-02 an

\*\* 4779101410624

4779101411621

4779101417623



### 2-GANG BLIND SWITCH WITH ILLUMINATION, WITHOUT FRAME

10 pcs. 10A, 250V~ IP20 PC Production by the order

\*Article number \*\* EAN code (V)



White



Ivory



Anthracite

\* P410-020-12 ww

P410-020-12 iv

P410-020-12 an

\*\* 4779101410709

4779101411706

4779101417708



### ROTARY DIMMER (20-400 W) OF LIGHT BULBS AND HV HALOGEN LAMPS, WITH FRAME

6 pcs. 250V~, 50Hz IP20 PC

\*Article number \*\* EAN code (V)



White



Ivory



Anthracite

\* ARMPM400 ww

ARMPM400 iv

ARMPM400 an

\*\* 4779101910476

4779101911473

4779101917475



### ROTARY DIMMER (40-600 W) OF LIGHT BULBS AND HV HALOGEN LAMPS, WITH FRAME

6 pcs. 250V~, 50Hz IP20 PC

\*Article number \*\* EAN code (V)



White



Ivory



Anthracite

\* ARMPM600 ww

ARMPM600 iv

ARMPM600 an

\*\* 4779101910537

4779101911534

4779101917536



### ROTARY DIMMER (1-100 W) OF LED DIMMABLE LAMPS, WITH FRAME

6 pcs. 250V~, 50Hz IP20 PC

\*Article number \*\* EAN code (V)



White



Ivory



Anthracite

\* ARMP LED ww

ARMP LED iv

ARMP LED an

\*\* 4779101910605

4779101911602

4779101911589

# SPECTRUM SP 300

## DIMMERS AND THERMOSTATS - SOCKET OUTLETS



### SOCKET OUTLET, WITHOUT FRAME

10 pcs. 16A, 250V~ IP20 PC

\*Article number \*\* EAN code (V)



White



Ivory



Anthracite

\* RP16-001-02 ww

RP16-001-02 iv

RP16-001-02 an

\*\* 4779101110500

4779101111507

4779101117509



### SOCKET OUTLET WITH SHUTTERS, WITHOUT FRAME

10 pcs. 16A, 250V~ IP20 PC

\*Article number \*\* EAN code (V)



White



Ivory



Anthracite

\* RP16-001-22 ww

RP16-001-22 iv

RP16-001-22 an

\*\* 4779101110548

4779101111545

4779101117547



### SCHUKO SOCKET OUTLET, WITHOUT FRAME

10 pcs. 16A, 250V~ IP20 PC

\*Article number \*\* EAN code (V)



White



Ivory



Anthracite

\* RP16-002-02 ww

RP16-002-02 iv

RP16-002-02 an

\*\* 4779101110524

4779101111521

4779101117523



### SCHUKO SOCKET OUTLET WITH SHUTTERS, WITHOUT FRAME

10 pcs. 16A, 250V~ IP20 PC

\*Article number \*\* EAN code (V)



White



Ivory



Anthracite

\* RP16-002-22 ww

RP16-002-22 iv

RP16-002-22 an

\*\* 4779101110562

4779101111569

4779101117561



### SCHUKO SOCKET OUTLET WITH HINGED LID (IP44), WITHOUT FRAME

10 pcs. 16A, 250V~ IP44 PC

\*Article number \*\* EAN code (V)



White



Ivory



Anthracite

\* RP16-003-02 ww

RP16-003-02 iv

RP16-003-02 an

\*\* 4779101110579

4779101111576

4779101117578

# SPECTRUM SP 300

## TELEPHONE AND DATA OUTLETS



### 1-GANG TELEPHONE OUTLET (1XRJ11 CAT3E), WITHOUT FRAME

10 pcs. IP20 PC

\*Article number \*\* EAN code (V)



White



Ivory



Anthracite

\* TLRJ11-131-02 ww TLRJ11-131-02 iv TLRJ11-131-02 an

\*\* 4779101630862 4779101631869 4779101637861



### 2-GANG TELEPHONE OUTLET (2XRJ11 CAT3E), WITHOUT FRAME

10 pcs. IP20 PC Production by the order

\*Article number \*\* EAN code (V)



White



Ivory



Anthracite

\* TLRJ11-231-02 ww TLRJ11-231-02 iv TLRJ11-231-02 an

\*\* 4779101630879 4779101631876 4779101637878



### TELEPHONE AND DATA OUTLET (RJ11XRJ45 CAT3XCAT5E UTP), WITHOUT FRAME

10 pcs. IP20 PC

\*Article number \*\* EAN code (V)



White



Ivory



Anthracite

\* TKLRJ35e2-02 ww TKLRJ35e2-02 iv TKLRJ35e2-02 an

\*\* 4779101610475 4779101611472 4779101617474



### 1-GANG DATA OUTLET (1XRJ45 CAT5E UTP), WITHOUT FRAME

10 pcs. IP20 PC

\*Article number \*\* EAN code (V)



White



Ivory



Anthracite

\* KLRJ45-15e2-02 ww KLRJ45-15e2-02 iv KLRJ45-15e2-02 an

\*\* 4779101610444 4779101611441 4779101617443



### 2-GANG DATA OUTLET (2XRJ45 CAT5E UTP), WITHOUT FRAME

10 pcs. IP20 PC

\*Article number \*\* EAN code (V)



White



Ivory



Anthracite

\* KLRJ45-25e2-02 ww KLRJ45-25e2-02 iv KLRJ45-25e2-02 an

\*\* 4779101610468 4779101611465 4779101617467

# SPECTRUM SP 300

## TELEPHONE AND DATA OUTLETS



### 1-GANG DATA OUTLET (1XRJ45 CAT5E UTP AMP), WITHOUT FRAME

10 pcs. IP20 PC Production by the order

\*Article number \*\* EAN code (V)



White



Ivory



Anthracite

\* KLRJ45-15e1-02 ww KLRJ45-15e1-02 iv KLRJ45-15e1-02 an

\*\* 4779101610437 4779101611434 4779101617436



### 2-GANG DATA OUTLET (2XRJ45 CAT5E UTP AMP), WITHOUT FRAME

10 pcs. IP20 PC Production by the order

\*Article number \*\* EAN code (V)



White



Ivory



Anthracite

\* KLRJ45-25e1-02 ww KLRJ45-25e1-02 iv KLRJ45-25e1-02 an

\*\* 4779101610451 4779101611458 4779101617450

# SPECTRUM SP 300

## TV SOCKET OUTLETS · LOUDSPEAKER OUTLETS



### TV SOCKET OUTLET, ENDING, WITHOUT FRAME

10 pcs. IP20 PC

\*Article number \*\* EAN code (V)



White



Ivory



Anthracite

\* TVL01-02 ww

TVL01-02 iv

TVL01-02 an

\*\* 4779101610253

4779101611250

4779101617252



### TV+R SOCKET OUTLET, ENDING, WITHOUT FRAME

10 pcs. IP20 PC

\*Article number \*\* EAN code (V)



White



Ivory



Anthracite

\* TVL02-02 ww

TVL02-02 iv

TVL02-02 an

\*\* 4779101610260

4779101611267

4779101617269



### TV+R+SAT SOCKET OUTLET, ENDING, WITHOUT FRAME

10 pcs. IP20 PC

\*Article number \*\* EAN code (V)



White



Ivory



Anthracite

\* TVL03-02 ww

TVL03-02 iv

TVL03-02 an

\*\* 4779101610413

4779101611410

4779101617412



### 4-GANG LOUDSPEAKER OUTLET, WITHOUT FRAME

10 pcs. IP20 PC

\*Article number \*\* EAN code (V)



White



Ivory



Anthracite

\* GL04-02 ww

GL04-02 iv

GL04-02 an

\*\* 4779101610512

4779101611526

4779101617511

# SPECTRUM SP 300

## FRAMES



### 1-GANG FRAME

60 pcs. PC

\*Article number \*\* EAN code (V)



White



Ivory



Anthracite

\* R01 ww

R01 iv

R01 an

\*\* 4779101510348

4779101511345

4779101517347



### 2-GANG FRAME

30 pcs. PC

\*Article number \*\* EAN code (V)



White



Ivory



Anthracite

\* R02 ww

R02 iv

R02 an

\*\* 4779101510355

4779101511352

4779101517354



### 3-GANG FRAME

20 pcs. PC

\*Article number \*\* EAN code (V)



White



Ivory



Anthracite

\* R03 ww

R03 iv

R03 an

\*\* 4779101510362

4779101511369

4779101517361



### 4-GANG FRAME

10 pcs. PC

\*Article number \*\* EAN code (V)



White



Ivory



Anthracite

\* R04 ww

R04 iv

R04 an

\*\* 4779101510379

4779101511376

4779101517378

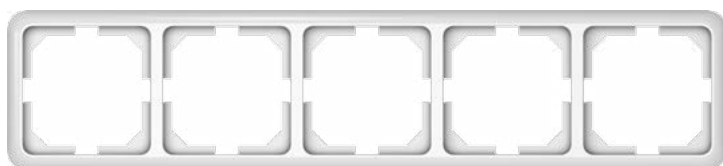

### 5-GANG FRAME

10 pcs. PC

\*Article number \*\* EAN code (V)



White



Ivory



Anthracite

\* R05 ww

R05 iv

R05 an

\*\* 4779101510386

4779101511383

4779101517385



# SPECTRUM SP 300

## ACCESSORIES



### MOUNTING PLATE FOR 1XRJ SOCKET WITH COVER PLATE, WITHOUT FRAME

10 pcs. PC

\*Article number \*\* EAN code (V)



White



Ivory



Anthracite

\* KLRJ45-1 ww

KLRJ45-1 iv

KLRJ45-1 an

\*\* 4779101700152

4779101701159

4779101707151

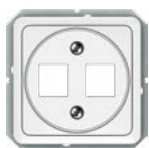

### MOUNTING PLATE FOR 2XRJ SOCKET WITH COVER PLATE, WITHOUT FRAME

10 pcs. PC

\*Article number \*\* EAN code (V)



White



Ivory



Anthracite

\* KLRJ45-2 ww

KLRJ45-2 iv

KLRJ45-2 an

\*\* 4779101700169

4779101701166

4779101707168

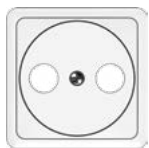

### TV+R COVER PLATE, WITHOUT FRAME

30 pcs. PC

\*Article number \*\* EAN code (V)



White



Ivory



Anthracite

\* TVA02 ww

TVA02 iv

TVA02 an

\*\* 4779101700176

4779101701173

4779101707175

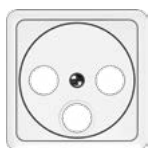

### TV+R+SAT COVER PLATE, WITHOUT FRAME

30 pcs. PC

\*Article number \*\* EAN code (V)



White



Ivory



Anthracite

\* TVA03 ww

TVA03 iv

TVA03 an

\*\* 4779101700183

4779101701180

4779101707182



### INSERT FOR SWITCHES (INTERMEDIATE FRAME)

50 pcs. PC

\*Article number \*\* EAN code (V)



White



Ivory



Anthracite

\* 754.152.009 ww

754.152.009 iv

754.152.009 an

\*\* 4779101500400

4779101501407



4779101507409

# SPECTRUM SP 300

## ACCESSORIES



### INSERT FOR SOCKETS (INTERMEDIATE FRAME)

 50 pcs.  PC

\*Article number \*\* EAN code (V)



White



Ivory



Anthracite

\* 754.152.008 ww

754.152.008 iv

754.152.008 an

\*\* 4779101500394

4779101501391

4779101507393



# STANDARD ST 150

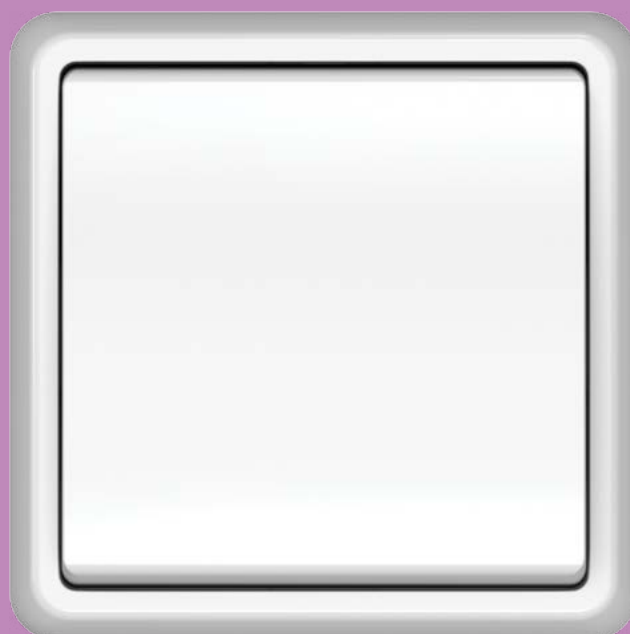

---

**STANDARD ST 150** series is for those who want ergonomicity and functionality in the daily environment. The clear rectangular shape gives a feeling of strength and reliability, while the large selection of colours in this series allows the possibility to choose from either bright and contrasting colours, or pastel interiors.

# STANDARD ST 150

## SWITCHES



### 1-GANG SWITCH, WITHOUT FRAME

10 pcs. 10A, 250V~ IP20 ABS

\*Article number \*\* EAN code (V) \*\*\* EAN code (D)



White



Ivory



Metallic



Grey



Red



Brown

* P110-010-02 ww	P110-010-02 iv	P110-010-02 mt	P110-010-02 gr	P110-010-02 rd	P110-010-02 br
** 4779101210095	4779101211092	4779101219098	4779101212099	4779101214093	4779101213096
*** 4779101200096					



### 1-GANG SWITCH WITH ILLUMINATION, WITHOUT FRAME

10 pcs. 10A, 250V~ IP20 ABS

\*Article number \*\* EAN code (V) \*\*\* EAN code (D)



White



Ivory



Metallic



Grey



Red



Brown

* P110-010-12 ww	P110-010-12 iv	P110-010-12 mt	P110-010-12 gr	P110-010-12 rd	P110-010-12 br
** 4779101210101	4779101211108	4779101219104	4779101212105	4779101214109	4779101213102



### 1-GANG SWITCH (IP44), WITHOUT FRAME

10 pcs. 10A, 250V~ IP44 ABS

\*Article number \*\* EAN code (V) \*\*\* EAN code (D)



White



Ivory



Metallic

* P110-010-04 ww	P110-010-04 iv	P110-010-04 mt
** 4779101210514	4779101211511	4779101219326



### 1-GANG 2 POLE SWITCH, WITHOUT FRAME

10 pcs. 10A, 250V~ IP20 ABS Production by the order

\*Article number \*\* EAN code (V) \*\*\* EAN code (D)



White



Ivory



Metallic

* P210-010-02 ww	P210-010-02 iv	P210-010-02 mt
** 4779101210231	4779101211238	4779101219234



### 1-GANG 2 POLE SWITCH WITH ILLUMINATION, WITHOUT FRAME

10 pcs. 10A, 250V~ IP20 ABS Production by the order

\*Article number \*\* EAN code (V) \*\*\* EAN code (D)



White

* P210-010-12 ww
** 4779101210255

# STANDARD ST 150

## SWITCHES



### 1-GANG 2 POLE SWITCH (IP44), WITHOUT FRAME

10 pcs. 10A, 250V~ IP44 ABS Production by the order

\*Article number \*\* EAN code (V) \*\*\* EAN code (D)



White



Ivory



Metallic

* P210-010-04 ww	P210-010-04 iv	P210-010-04 mt
** 4779101210552	4779101211542	4779101219357



### 2-GANG SWITCH, WITHOUT FRAME

10 pcs. 10A, 250V~ IP20 ABS

\*Article number \*\* EAN code (V) \*\*\* EAN code (D)



White



Ivory



Metallic



Grey



Red



Brown

* P510-020-02 ww	P510-020-02 iv	P510-020-02 mt	P510-020-02 gr	P510-020-02 rd	P510-020-02 br
** 4779101310139	4779101311136	4779101319132	4779101312133	4779101314137	4779101313130
*** 4779101300130					



### 2-GANG SWITCH WITH ILLUMINATION, WITHOUT FRAME

10 pcs. 10A, 250V~ IP20 ABS

\*Article number \*\* EAN code (V) \*\*\* EAN code (D)



White



Ivory



Metallic



Grey



Red



Brown

* P510-020-12 ww	P510-020-12 iv	P510-020-12 mt	P510-020-12 gr	P510-020-12 rd	P510-020-12 br
** 4779101310146	4779101311143	4779101319149	4779101312140	4779101314144	4779101313147



### 2-GANG SWITCH (IP44), WITHOUT FRAME

10 pcs. 10A, 250V~ IP44 ABS

\*Article number \*\* EAN code (V) \*\*\* EAN code (D)



White



Ivory



Metallic

* P510-020-04 ww	P510-020-04 iv	P510-020-04 mt
** 4779101310153	4779101311150	4779101319156

# STANDARD ST 150

## TWO-WAY SWITCHES



### 1-GANG TWO-WAY SWITCH, WITHOUT FRAME

10 pcs. 10A, 250V~ IP20 ABS

\*Article number \*\* EAN code (V) \*\*\* EAN code (D)



White



Ivory



Metallic



Grey



Red



Brown

* P610-010-02 ww	P610-010-02 iv	P610-010-02 mt	P610-010-02 gr	P610-010-02 rd	P610-010-02 br
** 4779101410174	4779101411171	4779101419177	4779101412178	4779101414172	4779101413175
*** 4779101400175					



### 1-GANG TWO-WAY SWITCH WITH ILLUMINATION, WITHOUT FRAME

10 pcs. 10A, 250V~ IP20 ABS

\*Article number \*\* EAN code (V) \*\*\* EAN code (D)



White



Ivory



Metallic



Grey



Red



Brown

* P610-010-12 ww	P610-010-12 iv	P610-010-12 mt	P610-010-12 gr	P610-010-12 rd	P610-010-12 br
** 4779101410181	4779101411188	4779101419184	4779101412185	4779101414189	4779101413182



### 1-GANG TWO-WAY SWITCH (IP44), WITHOUT FRAME

10 pcs. 10A, 250V~ IP44 ABS Production by the order

\*Article number \*\* EAN code (V) \*\*\* EAN code (D)



White



Ivory



Metallic

* P610-010-04 ww	P610-010-04 iv	P610-010-04 mt
** 4779101410723	4779101411720	4779101419696



### 2-GANG TWO-WAY SWITCH, WITHOUT FRAME

10 pcs. 10A, 250V~ IP20 ABS

\*Article number \*\* EAN code (V) \*\*\* EAN code (D)



White



Ivory



Metallic

* P(6+6)10-020-02 ww	P(6+6)10-020-02 iv	P(6+6)10-020-02 mt
** 4779101410358	4779101411355	4779101419351



### 2-GANG TWO-WAY SWITCH (IP44), WITHOUT FRAME

10 pcs. 10A, 250V~ IP44 ABS Production by the order

\*Article number \*\* EAN code (V) \*\*\* EAN code (D)



White



Ivory



Metallic

* P(6+6)10-020-04 ww	P(6+6)10-020-04 iv	P(6+6)10-020-04 mt
** 4779101410778	4779101411775	4779101419733

# STANDARD ST 150

## TWO-WAY SWITCHES



### 1-GANG INTERMEDIATE SWITCH, WITHOUT FRAME

10 pcs. 10A, 250V~ IP20 ABS

\*Article number \*\* EAN code (V) \*\*\* EAN code (D)



White



Ivory



Metallic

* P710-010-02 ww	P710-010-02 iv	P710-010-02 mt
** 4779101410457	4779101411454	4779101419450



### 1-GANG INTERMEDIATE SWITCH WITH ILLUMINATION, WITHOUT FRAME

10 pcs. 10A, 250V~ IP20 ABS

\*Article number \*\* EAN code (V) \*\*\* EAN code (D)



White



Ivory



Metallic

* P710-010-12 ww	P710-010-12 iv	P710-010-12 mt
** 4779101410471	4779101411478	4779101419474



### 1-GANG INTERMEDIATE SWITCH (IP44), WITHOUT FRAME

10 pcs. 10A, 250V~ IP44 ABS Production by the order

\*Article number \*\* EAN code (V) \*\*\* EAN code (D)



White



Ivory



Metallic

* P710-010-04 ww	P710-010-04 iv	P710-010-04 mt
** 4779101410747	4779101411744	4779101419719



# STANDARD ST 150

## PUSH-BUTTON SWITCHES “BELL” · BLINDS SWITCHES



### 1-GANG PUSH-BUTTON SWITCH “BELL”, WITH FRAME

10 pcs. 10A, 250V~ IP20 ABS

\*Article number \*\* EAN code (V) \*\*\* EAN code (D)



White



Ivory



Metallic

\* P110-012 ww

P110-012 iv

P110-012 mt

\*\* 4779101810448

4779101811445

4779101819441



### 1-GANG PUSH-BUTTON SWITCH “BELL” WITH ILLUMINATION, WITH FRAME

10 pcs. 10A, 250V~ IP20 ABS

\*Article number \*\* EAN code (V) \*\*\* EAN code (D)



White



Ivory



Metallic

\* P110-012-10 ww

P110-012-10 iv

P110-012-10 mt

\*\* 4779101810455

4779101811452

4779101819458



### 2-GANG BLIND SWITCH, WITHOUT FRAME

10 pcs. 10A, 250V~ IP20 ABS

\*Article number \*\* EAN code (V) \*\*\* EAN code (D)



White



Ivory



Metallic

\* P410-020-02 ww

P410-020-02 iv

P410-020-02 mt

\*\* 4779101410259

4779101411256

4779101419252



### 2-GANG BLIND SWITCH WITH ILLUMINATION, WITHOUT FRAME

10 pcs. 10A, 250V~ IP20 ABS Production by the order

\*Article number \*\* EAN code (V) \*\*\* EAN code (D)



White



Ivory



Metallic

\* P410-020-12 ww

P410-020-12 iv

P410-020-12 mt

\*\* 4779101410273

4779101411270

4779101419276



### 2-GANG BLIND SWITCH (IP44), WITHOUT FRAME

10 pcs. 10A, 250V~ IP44 ABS Production by the order

\*Article number \*\* EAN code (V) \*\*\* EAN code (D)



White



Ivory



Metallic

\* P410-020-04 ww

P410-020-04 iv

P410-020-04 mt

\*\* 4779101410808

4779101411805

4779101419757

# STANDARD ST 150

## DIMMERS AND THERMOSTATS - SOCKET OUTLETS



### ROTARY DIMMER (20-400 W) OF LIGHT BULBS AND HV HALOGEN LAMPS, WITH FRAME

6 pcs. ⚡ 250V~, 50Hz~ IP20 ABS

\*Article number \*\* EAN code (V) \*\*\* EAN code (D)



White



Ivory



Metallic

* ARMPM400 ww	ARMPM400 iv	ARMPM400 mt
** 4779101910490	4779101911497	4779101919493



### ROTARY DIMMER (40-600 W) OF LIGHT BULBS AND HV HALOGEN LAMPS, WITH FRAME

6 pcs. ⚡ 250V~, 50Hz~ IP20 ABS

\*Article number \*\* EAN code (V) \*\*\* EAN code (D)



White



Ivory



Metallic

* ARMPM600 ww	ARMPM600 iv	ARMPM600 mt
** 4779101910506	4779101911503	4779101919509



### ROTARY DIMMER (1-100 W) OF LED DIMMABLE LAMPS, WITH FRAME

6 pcs. ⚡ 250V~, 50Hz~ IP20 ABS

\*Article number \*\* EAN code (V) \*\*\* EAN code (D)



White



Ivory



Metallic

* ARMP LED ww	ARMP LED iv	ARMP LED mt
** 4779101910582	4779101911589	4779101919578



### SOCKET OUTLET, WITHOUT FRAME

10 pcs. ⚡ 10A, 250V~ IP20 ABS

\*Article number \*\* EAN code (V) \*\*\* EAN code (D)



White



Ivory



Metallic



Grey



Red



Brown

* RP16-001-02 ww	RP16-001-02 iv	RP16-001-02 mt	RP16-001-02 gr	RP16-001-02 rd	RP16-001-02 br
** 4779101110029	4779101111026	4779101119022	4779101112023	4779101114027	4779101113020
*** 4779101100020					

# STANDARD ST 150

## SOCKET OUTLETS



### SOCKET OUTLET WITH SHUTTERS, WITHOUT FRAME

10 pcs. 10A, 250V~ IP20 ABS

\*Article number \*\* EAN code (V) \*\*\* EAN code (D)



White



Ivory



Metallic

* RP16-001-22 ww	RP16-001-22 iv	RP16-001-22 mt
** 4779101110265	4779101111262	4779101119268



### SCHUKO SOCKET OUTLET, WITHOUT FRAME

10 pcs. 10A, 250V~ IP20 ABS

\*Article number \*\* EAN code (V) \*\*\* EAN code (D)



White



Ivory



Metallic



Grey



Red



Brown

* PRP16-002-02 ww	RP16-002-02 iv	RP16-002-02 mt	RP16-002-02 gr	RP16-002-02 rd	RP16-002-02 br
** 4779101110043	4779101111040	4779101119046	4779101112047	4779101114041	4779101113044
*** 4779101100044					



### SCHUKO SOCKET OUTLET WITH SHUTTERS, WITHOUT FRAME

10 pcs. 10A, 250V~ IP20 ABS

\*Article number \*\* EAN code (V) \*\*\* EAN code (D)



White



Ivory



Metallic

* RP16-002-22 ww	RP16-002-22 iv	RP16-002-22 mt
** 4779101110289	4779101111286	4779101119282



### SCHUKO SOCKET OUTLET WITH HINGED LID (IP44), WITHOUT FRAME

10 pcs. 10A, 250V~ IP20 ABS

\*Article number \*\* EAN code (V) \*\*\* EAN code (D)



White



Ivory



Metallic

* RP16-003-02 ww	RP16-003-02 iv	RP16-003-02 mt
** 4779101110463	4779101111460	4779101119411



### SCHUKO SOCKET OUTLET WITH HINGED LID AND WITH SHUTTERS (IP44), WITHOUT FRAME

10 pcs. 10A, 250V~ IP44 ABS

\*Article number \*\* EAN code (V) \*\*\* EAN code (D)



White



Ivory



Metallic

* RP16-003-22 ww	RP16-003-22 iv	RP16-003-22 mt
** 477910111693	477910111694	477910111695

# STANDARD ST 150

## SOCKET OUTLETS · TELEPHONE AND DATA OUTLETS

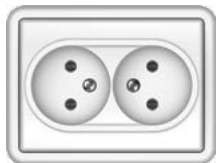

### 2-GANG SOCKET OUTLET

10 pcs. 10A, 250V~ IP20 ABS

\*Article number \*\* EAN code (V) \*\*\* EAN code (D)



White



Ivory



Metallic



Grey



Red



Brown

\* RP16-020 ww

RP16-020 iv

RP16-020 mt

RP16-020 gr

RP16-020 rd

RP16-020 br

\*\* 4779101110050

4779101111057

4779101119053

4779101112054

4779101114058

4779101113051



### SCHUKO 2-GANG SOCKET OUTLET

10 pcs. 10A, 250V~ IP20 ABS

\*Article number \*\* EAN code (V) \*\*\* EAN code (D)



White



Ivory



Metallic



Grey



Red



Brown

\* RP16-021 ww

RP16-021 iv

RP16-021 mt

RP16-021 gr

RP16-021 rd

RP16-021 br

\*\* 4779101110067

4779101111064

4779101119060

4779101112061

4779101114065

4779101113068



### 1-GANG TELEPHONE OUTLET (1XRJ11 CAT3E), WITHOUT FRAME

10 pcs. IP20 ABS

\*Article number \*\* EAN code (V) \*\*\* EAN code (D)



White



Ivory



Metallic

\* TLRJ11-131-02 ww

TLRJ11-131-02 iv

TLRJ11-131-02 mt

\*\* 4779101630466

4779101631463

4779101639469



### 2-GANG TELEPHONE OUTLET (2XRJ11 CAT3E), WITHOUT FRAME

10 pcs. IP20 ABS Production by the order

\*Article number \*\* EAN code (V) \*\*\* EAN code (D)



White



Ivory



Metallic

\* TLRJ11-231-02 ww

TLRJ11-231-02 iv

TLRJ11-231-02 mt

\*\* 4779101630121

4779101631128

4779101639124



### TELEPHONE AND DATA OUTLET (RJ11XRJ45 CAT3XCAT5E UTP), WITHOUT FRAME

10 pcs. IP20 ABS

\*Article number \*\* EAN code (V) \*\*\* EAN code (D)



White



Ivory



Metallic

\* TKLRJ35e2-02 ww

TKLRJ35e2-02 iv

TKLRJ35e2-02 mt

\*\* 4779101630503

4779101631494

4779101639490

# STANDARD ST 150

## TELEPHONE AND DATA OUTLETS



### 1-GANG DATA OUTLET (1XRJ45 CAT5E UTP), WITHOUT FRAME

10 pcs. IP20 ABS

\*Article number \*\* EAN code (V) \*\*\* EAN code (D)



White



Ivory



Metallic

\* KLRJ45-15e2-02 ww KLRJ45-15e2-02 iv KLRJ45-15e2-02 mt

\*\* 4779101630268 4779101631265 4779101639261



### 2-GANG DATA OUTLET (2XRJ45 CAT5E UTP), WITHOUT FRAME

10 pcs. IP20 ABS

\*Article number \*\* EAN code (V) \*\*\* EAN code (D)



White



Ivory



Metallic

\* KLRJ45-25e2-02 ww KLRJ45-25e2-02 iv KLRJ45-25e2-02 mt

\*\* 4779101630305 4779101631302 4779101639308



### 1-GANG DATA OUTLET (1XRJ45 CAT5E UTP AMP), WITHOUT FRAME

10 pcs. IP20 ABS Production by the order

\*Article number \*\* EAN code (V) \*\*\* EAN code (D)



White



Ivory



Metallic

\* KLRJ45-15e1-02 ww KLRJ45-15e1-02 iv KLRJ45-15e1-02 mt

\*\* 4779101630442 4779101631449 4779101639445



### 2-GANG DATA OUTLET (2XRJ45 CAT5E UTP AMP), WITHOUT FRAME

10 pcs. IP20 ABS Production by the order

\*Article number \*\* EAN code (V) \*\*\* EAN code (D)



White



Ivory



Metallic

\* KLRJ45-25e1-02 ww KLRJ45-25e1-02 iv KLRJ45-25e1-02 mt

\*\* 4779101630473 4779101631227 4779101639223

# STANDARD ST 150

## TV SOCKET OUTLETS



### TV SOCKET OUTLET, ENDING, WITHOUT FRAME

10 pcs. IP20 ABS

\*Article number \*\* EAN code (V) \*\*\* EAN code (D)



White



Ivory



Metallic

* TVL01-02 ww	TVL01-02 iv	TVL01-02 mt
** 4779101630725	4779101631722	4779101639520



### SAT SOCKET OUTLET, ENDING, WITHOUT FRAME

10 pcs. IP20 ABS

\*Article number \*\* EAN code (V) \*\*\* EAN code (D)



White



Ivory



Metallic

* SAT01-02ww	SAT01-02 iv	SAT01-02 mt
** 4779101630183	4779101631098	4779101639162



### TV+R SOCKET OUTLET, ENDING, WITHOUT FRAME

10 pcs. IP20 ABS

\*Article number \*\* EAN code (V) \*\*\* EAN code (D)



White



Ivory



Metallic



Grey



Red



Brown

* TVL02-02 ww	TVL02-02 iv	TVL02-02 mt	TVL02-02 gr	TVL02-02 rd	TVL02-02 br
** 4779101610567	4779101611571	4779101619621	4779101612585	4779101614602	4779101613599



### TV+R+SAT SOCKET OUTLET, ENDING, WITHOUT FRAME

10 pcs. IP20 ABS

\*Article number \*\* EAN code (V) \*\*\* EAN code (D)



White



Ivory



Metallic



Grey



Red



Brown

* TVL03-02 ww	TVL03-02 iv	TVL03-02 mt	TVL03-02 gr	TVL03-02 rd	TVL03-02 br
** 4779101610840	4779101611854	4779101619904	4779101612868	4779101614886	4779101613872



### TV+DATA DOUBLE OUTLET (TVXRJ45), WITHOUT FRAME

10 pcs. IP20 ABS

\*Article number \*\* EAN code (V) \*\*\* EAN code (D)



White



Ivory



Metallic

* TVL/KLRJ45-15e2-02 ww	TVL/KLRJ45-15e2-02 iv	TVL/KLRJ45-15e2-02 mt
** 4779101630787	4779101631784	4779101639568

# STANDARD ST 150

## LOUDSPEAKER OUTLETS



### SAT+DATA OUTLET (SAT+RJ45), WITHOUT FRAME

10 pcs. IP20 ABS

\*Article number \*\* EAN code (V) \*\*\* EAN code (D)



White



Ivory



Metallic

\* SAT/KLRJ45-15e2-02 ww SAT/KLRJ45-15e2-02 iv SAT/KLRJ45-15e2-02 mt

\*\* 4779101630978 4779101631357 4779101639483



### 4-GANG LOUDSPEAKER OUTLET, WITHOUT FRAME

10 pcs. IP20 ABS

\*Article number \*\* EAN code (V) \*\*\* EAN code (D)



White



Ivory



Metallic

\* GL04-02 ww GL04-02 iv GL04-02 mt

\*\* 4779101630169 4779101631340 4779101639834

# STANDARD ST 150

## FRAMES



### 1-GANG FRAME

40 pcs. ABS

\*Article number \*\* EAN code (V) \*\*\* EAN code (D)



White



Ivory



Metallic



Grey



Red



Brown

\* R01 ww

R01 iv

R01 mt

R01 gr

R01 rd

R01 br

\*\* 4779101510232

4779101511239

4779101519235

4779101512236

4779101514230

4779101513233

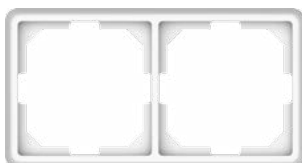

### 2-GANG FRAME

20 pcs. ABS

\*Article number \*\* EAN code (V) \*\*\* EAN code (D)



White



Ivory



Metallic



Grey



Red



Brown

\* R02 ww

R02 iv

R02 mt

R02 gr

R02 rd

R02 br

\*\* 4779101510249

4779101511246

4779101519242

4779101512243

4779101514247

4779101513240

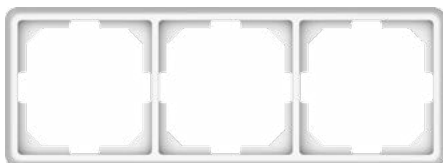

### 3-GANG FRAME

15 pcs. ABS

\*Article number \*\* EAN code (V) \*\*\* EAN code (D)



White



Ivory



Metallic



Grey



Red



Brown

\* R03 ww

R03 iv

R03 mt

R03 gr

R03 rd

R03 br

\*\* 4779101510256

4779101511253

4779101519259

4779101512250

4779101514254

4779101513257

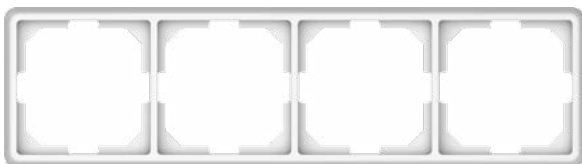

### 4-GANG FRAME

10 pcs. ABS

\*Article number \*\* EAN code (V) \*\*\* EAN code (D)



White



Ivory



Metallic



Grey



Red



Brown

\* R04 ww

R04 iv

R04 mt

R04 gr

R04 rd

R04 br

\*\* 4779101510263

4779101511260

4779101519266

4779101512267

4779101514261

4779101513264

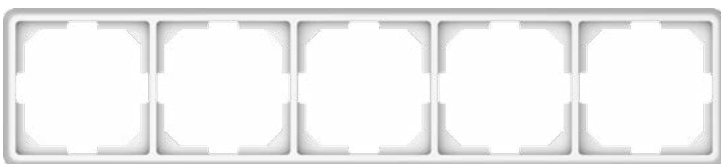

### 5-GANG FRAME

10 pcs. ABS

\*Article number \*\* EAN code (V) \*\*\* EAN code (D)



White



Ivory



Metallic

\* R05 ww

R05 iv

R05 mt

\*\* 4779101510270

4779101511277

4779101519273



# STANDARD ST 150

## ACCESSORIES



### MOUNTING PLATE FOR 1XRJ SOCKET WITH COVER PLATE, WITHOUT FRAME

30 pcs. ABS

\*Article number \*\* EAN code (V) \*\*\* EAN code (D)



White



Ivory



Metallic

\* KLRJ45-1 ww

KLRJ45-1 iv

KLRJ45-1mt

\*\* 4779101700022

4779101701050

4779101709025



### MOUNTING PLATE FOR 2XRJ SOCKET WITH COVER PLATE, WITHOUT FRAME

30 pcs. ABS

\*Article number \*\* EAN code (V) \*\*\* EAN code (D)



White



Ivory



Metallic

\* KLRJ45-2 ww

KLRJ45-2 iv

KLRJ45-2 mt

\*\* 4779101700039

4779101701135

4779101709032



### TV+R COVER PLATE, WITHOUT FRAME

30 pcs. ABS

\*Article number \*\* EAN code (V) \*\*\* EAN code (D)



White



Ivory



Metallic

\* TVA02 ww

TVA02 iv

TVA02 mt

\*\* 4779101700077

4779101701197

4779101709070



### TV+R+SAT COVER PLATE, WITHOUT FRAME

30 pcs. ABS

\*Article number \*\* EAN code (V) \*\*\* EAN code (D)



White



Ivory



Metallic

\* TVA03 ww

TVA03 iv

TVA03 mt

\*\* 4779101700084

4779101701203



4779101709087

# STANDARD ST 150

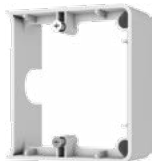
## ACCESSORIES



### SURFACE MOUNTING BOX CONNECTING (RIGHT ENDING)

 10 pcs.  ABS

\*Article number \*\* EAN code (V) \*\*\* EAN code (D)



 White

\* 757.519.007 ww

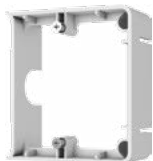
\*\* 4779101710496



### SURFACE MOUNTING BOX CONNECTING (CENTRAL)

 10 pcs.  ABS

\*Article number \*\* EAN code (V) \*\*\* EAN code (D)



 White

\* 757.519.007-01 ww

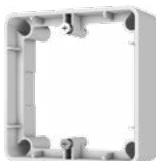
\*\* 4779101710502



### SURFACE MOUNTING BOX

 10 pcs.  ABS

\*Article number \*\* EAN code (V) \*\*\* EAN code (D)



 White

\* 757.519.008 ww

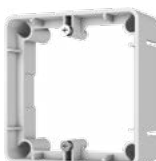
\*\* 4779101710472



### SURFACE MOUNTING BOX CONNECTING (LEFT ENDING)

 10 pcs.  ABS

\*Article number \*\* EAN code (V) \*\*\* EAN code (D)

 White

\* 757.519.008-01 ww

\*\* 4779101710489

# STYLE SL 250



**STYLE SL 250** series is marked for its practicality and simplicity. The subtle design easily fits into any interior, while the functionality of the products in this series ensures implementation of the main light and power management solutions.



# STYLE SL 250

## SWITCHES



### 1-GANG SWITCH, WITHOUT FRAME

10 pcs. 10A, 250V~ IP20 ABS

\*Article number \*\* EAN code (V) \*\*\* EAN code (D)



White



Ivory



Metallic



Champagne



Anthracite

* P110-010-02 ww	P110-010-02 iv	P110-010-02 mt	P110-010-02 ch	P110-010-02 an
** 4779101210064	4779101211061	4779101219418	4779101216011	4779101217612
*** 4779101200065				



### 1-GANG SWITCH WITH ILLUMINATION, WITHOUT FRAME

10 pcs. 10A, 250V~ IP20 ABS

\*Article number \*\* EAN code (V) \*\*\* EAN code (D)



White



Ivory



Metallic



Champagne



Anthracite

* P110-010-12 ww	P110-010-12 iv	P110-010-12 mt	P110-010-12 ch	P110-010-12 an
** 4779101210262	4779101211269	4779101219425	4779101216028	4779101217629



### 1-GANG 2 POLE SWITCH, WITHOUT FRAME

10 pcs. 10A, 250V~ IP20 ABS Production by the order

\*Article number \*\* EAN code (V) \*\*\* EAN code (D)



White



Ivory



Metallic



Champagne



Anthracite

* P210-010-02 ww	P210-010-02 iv	P210-010-02 mt	P210-010-02 ch	P210-010-02 an
** 4779101410549	4779101411546	4779101419771	4779101416015	4779101417210



### 1-GANG 2 POLE SWITCH WITH ILLUMINATION, WITHOUT FRAME

10 pcs. 10A, 250V~ IP20 ABS Production by the order

\*Article number \*\* EAN code (V) \*\*\* EAN code (D)



White



Ivory



Metallic



Champagne



Anthracite

* P210-010-12 ww	P210-010-12 iv	P210-010-12 mt	P210-010-12 ch	P210-010-12 an
** 4779101410570	4779101411577	4779101419788	4779101416022	4779101417227



### 2-GANG SWITCH, WITHOUT FRAME

10 pcs. 10A, 250V~ IP20 ABS

\*Article number \*\* EAN code (V) \*\*\* EAN code (D)



White



Ivory



Metallic



Champagne



Anthracite

* P510-020-02 ww	P510-020-02 iv	P510-020-02 mt	P510-020-02 ch	P510-020-02 an
** 4779101310061	4779101311068	4779101219432	4779101216035	4779101217636
*** 4779101300062				

# STYLE SL 250

## SWITCHES · TWO-WAY SWITCHES



### 2-GANG SWITCH WITH ILLUMINATION, WITHOUT FRAME

10 pcs. 10A, 250V~ IP20 ABS

\*Article number \*\* EAN code (V) \*\*\* EAN code (D)



White



Ivory



Metallic



Champagne



Anthracite

\* P510-020-12 ww

P510-020-12 iv

P510-020-12 mt

P510-020-12 ch

P510-020-12 an

\*\* 4779101210279

4779101211276

4779101219449

4779101216042

4779101217643



### 1-GANG TWO-WAY SWITCH, WITHOUT FRAME

10 pcs. 10A, 250V~ IP20 ABS

\*Article number \*\* EAN code (V) \*\*\* EAN code (D)



White



Ivory



Metallic



Champagne



Anthracite

\* P610-010-02 ww

P610-010-02 iv

P610-010-02 mt

P610-010-02 ch

P610-010-02 an

\*\* 4779101410068

4779101411065

4779101219456

4779101216059

4779101217650



### 1-GANG TWO-WAY SWITCH WITH ILLUMINATION, WITHOUT FRAME

10 pcs. 10A, 250V~ IP20 ABS

\*Article number \*\* EAN code (V) \*\*\* EAN code (D)



White



Ivory



Metallic



Champagne



Anthracite

\* P610-010-12 ww

P610-010-12 iv

P610-010-12 mt

P610-010-12 ch

P610-010-12 an

\*\* 4779101210286

4779101211283

4779101219463

4779101216066

4779101217667



### 2-GANG TWO-WAY SWITCH, WITHOUT FRAME

10 pcs. 10A, 250V~ IP20 ABS

\*Article number \*\* EAN code (V) \*\*\* EAN code (D)



White



Ivory



Metallic



Champagne



Anthracite

\* P(6+6)10-020-02 ww

P(6+6)10-020-02 iv

P(6+6)10-020-02 mt

P(6+6)10-020-02 ch

P(6+6)10-020-02 an

\*\* 4779101410389

4779101411386

4779101419801

4779101416046

4779101417241



### 1-GANG INTERMEDIATE SWITCH, WITHOUT FRAME

10 pcs. 10A, 250V~ IP20 ABS

\*Article number \*\* EAN code (V) \*\*\* EAN code (D)



White



Ivory



Metallic



Champagne



Anthracite

\* P710-010-02 ww

P710-010-02 iv

P710-010-02 mt

P710-010-02 ch

P710-010-02 an

\*\* 4779101410396

4779101411393

4779101419818

4779101416053

4779101417258

# STYLE SL 250

## TWO-WAY SWITCHES · PUSH-BUTTON SWITCHES “BELL”

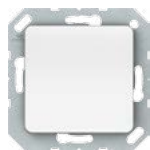

### 1-GANG INTERMEDIATE SWITCH WITH ILLUMINATION, WITHOUT FRAME

10 pcs. 10A, 250V~ IP20 ABS

\*Article number \*\* EAN code (V) \*\*\* EAN code (D)



White



Ivory



Metallic



Champagne



Anthracite

\* P710-010-12 ww

P710-010-12 iv

P710-010-12 mt

P710-010-12 ch

P710-010-12 an

\*\* 4779101410556

4779101411553

4779101419832

4779101416077

4779101417272



### 1-GANG PUSH-BUTTON SWITCH “BELL”, WITH FRAME

10 pcs. 10A, 250V~ IP20 ABS

\*Article number \*\* EAN code (V) \*\*\* EAN code (D)



White



Ivory



Metallic



Champagne



Anthracite

\* P110-012 ww

P110-012 iv

P110-012 mt

P110-012 ch

P110-012 an

\*\* 4779101810462

4779101811049

4779101819212

4779101816419

4779101817447

# STYLE SL 250

## BLINDS SWITCHES · SOCKET OUTLETS



### 2-GANG BLIND SWITCH, WITHOUT FRAME

10 pcs. 10A, 250V~ IP20 ABS

\*Article number \*\* EAN code (V) \*\*\* EAN code (D)



White



Ivory



Metallic



Champagne



Anthracite

* P410-020-02 ww	P410-020-02 iv	P410-020-02 mt	P410-020-02 ch	P410-020-02 an
** 4779101410488	4779101411485	4779101419795	4779101416039	4779101417234



### 2-GANG BLIND SWITCH WITH ILLUMINATION, WITHOUT FRAME

10 pcs. 10A, 250V~ IP20 ABS Production by the order

\*Article number \*\* EAN code (V) \*\*\* EAN code (D)



White



Ivory



Metallic



Champagne



Anthracite

* P410-020-12 ww	P410-020-12 iv	P410-020-12 mt	P410-020-12 ch	P410-020-12 an
** 4779101410563	4779101411560	4779101419825	4779101416060	4779101417265



### SOCKET OUTLET, WITHOUT FRAME

10 pcs. 16A, 250V~ IP20 ABS

\*Article number \*\* EAN code (V) \*\*\* EAN code (D)



White



Ivory



Metallic



Champagne



Anthracite

* RP16-001-02 ww	RP16-001-02 iv	RP16-001-02 mt	RP16-001-02 ch	RP16-001-02 an
** 4779101110166	4779101111163	4779101119466	4779101116014	4779101117257



### SOCKET OUTLET WITH SHUTTERS, WITHOUT FRAME

10 pcs. 16A, 250V~ IP20 ABS

\*Article number \*\* EAN code (V) \*\*\* EAN code (D)



White



Ivory



Metallic



Champagne



Anthracite

* RP16-001-22 ww	RP16-001-22 iv	RP16-001-22 mt	RP16-001-22 ch	RP16-001-22 an
** 4775101110456	4779101111453	4779101119480	4779101116038	4779101117271



### SCHUKO SOCKET OUTLET, WITHOUT FRAME

10 pcs. 16A, 250V~ IP20 ABS

\*Article number \*\* EAN code (V) \*\*\* EAN code (D)



White



Ivory



Metallic



Champagne



Anthracite

* RP16-002-02 ww	RP16-002-02 iv	RP16-002-02 mt	RP16-002-02 ch	RP16-002-02 an
** 4779101110180	4779101111187	4779101119497	4779101116045	4779101117288
*** 4779101100181				



# STYLE SL 250

## SOCKET OUTLETS



### SCHUKO SOCKET OUTLET WITH SHUTTERS, WITHOUT FRAME

10 pcs. 16A, 250V~ IP20 ABS

\*Article number \*\* EAN code (V) \*\*\* EAN code (D)



White



Ivory



Metallic



Champagne



Anthracite

\* RP16-002-22 ww

RP16-002-22 iv

RP16-002-22 mt

RP16-002-22 ch

RP16-002-22 an

\*\* 4779101110470

4779101111477

4779101119527

4779101116076

4779101117318



### SCHUKO SOCKET OUTLET WITH HINGED LID (IP44), WITHOUT FRAME

10 pcs. 16A, 250V~ IP44 ABS

\*Article number \*\* EAN code (V) \*\*\* EAN code (D)



White



Ivory



Metallic



Champagne



Anthracite

\* RP16-003-02 ww

RP16-003-02 iv

RP16-003-02 mt

RP16-003-02 ch

RP16-003-02 an

\*\* 4779101110593

4779101111590

4779101119510

4779101116069

4779101117301



### SCHUKO SOCKET OUTLET WITH HINGED LID AND WITH SHUTTERS (IP44), WITHOUT FRAME

10 pcs. 16A, 250V~ IP44 ABS

\*Article number \*\* EAN code (V) \*\*\* EAN code (D)



White



Ivory



Metallic



Champagne



Anthracite

\* RP16-003-22 ww

RP16-003-22 iv

RP16-003-22 mt

RP16-003-22 ch

RP16-003-22 an

\*\* 477910111696

477910111697

477910111698

477910111699

477910111700

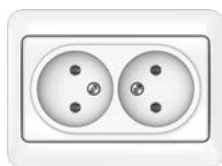

### 2-GANG SOCKET OUTLET

8 pcs. 16A, 250V~ IP20 ABS

\*Article number \*\* EAN code (V) \*\*\* EAN code (D)



White



Ivory



Metallic



Champagne



Anthracite

\* RP16-020 ww

RP16-020 iv

RP16-020 mt

RP16-020 ch

RP16-020 an

\*\* 4779101110098

4779101111095

4779101119473

4779101116021

4779101117264

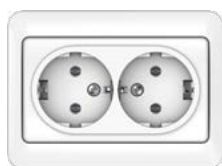

### SCHUKO 2-GANG SOCKET OUTLET

6 pcs. 16A, 250V~ IP20 ABS

\*Article number \*\* EAN code (V) \*\*\* EAN code (D)



White



Ivory



Metallic



Champagne



Anthracite

\* RP16-021 ww

RP16-021 iv

RP16-021 mt

RP16-021 ch

RP16-021 an

\*\* 4779101110104

4779101111101

4779101119503

4779101116052

4779101117295

# STYLE SL 250

## TELEPHONE AND DATA OUTLETS · TV SOCKET OUTLETS



### 1-GANG TELEPHONE OUTLET (1XRJ11 CAT3E), WITHOUT FRAME

10 pcs. IP20 ABS

\*Article number \*\* EAN code (V) \*\*\* EAN code (D)

White Ivory Metallic Champagne Anthracite

* TLRJ11-131-02 ww	TLRJ11-131-02 iv	TLRJ11-131-02 mt	TLRJ11-131-02 ch	TLRJ11-131-02 an
** 4779101630527	4779101631524	4779101639940	4779101636017	4779101637939



### 1-GANG DATA OUTLET (1XRJ45 CAT5E UTP), WITHOUT FRAME

10 pcs. IP20 ABS

\*Article number \*\* EAN code (V) \*\*\* EAN code (D)

White Ivory Metallic Champagne Anthracite

* KLRJ45-15e2-02 ww	KLRJ45-15e2-02 iv	KLRJ45-15e2-02 mt	KLRJ45-15e2-02 ch	KLRJ45-15e2-02 an
** 4779101630534	4779101631531	4779101639957	4779101636024	4779101637946



### 1-GANG DATA OUTLET (1XRJ45 CAT5E UTP AMP), WITHOUT FRAME

10 pcs. IP20 ABS Production by the order

\*Article number \*\* EAN code (V) \*\*\* EAN code (D)

White Ivory Metallic Champagne Anthracite

* KLRJ45-15e3-02 ww	KLRJ45-15e3-02 iv	KLRJ45-15e3-02 mt	KLRJ45-15e3-02 ch	KLRJ45-15e3-02 an
** 4779101630541	4779101631548	4779101639964	4779101636031	4779101637953



### TV SOCKET OUTLET, ENDING, WITHOUT FRAME

10 pcs. IP20 ABS

\*Article number \*\* EAN code (V) \*\*\* EAN code (D)

White Ivory Metallic Champagne Anthracite

* TVL01-02 ww	TVL01-02 iv	TVL01-02 mt	TVL01-02 ch	TVL01-02 an
** 4779101630558	4779101631555	4779101639971	4779101636048	4779101637960



### SAT SOCKET OUTLET, ENDING, WITHOUT FRAME

10 pcs. IP20 ABS

\*Article number \*\* EAN code (V) \*\*\* EAN code (D)

White Ivory Metallic Champagne Anthracite

* SAT01-02 ww	SAT01-02 iv	SAT01-02 mt	SAT01-02 ch	SAT01-02 an
** 4779101630749	4779101631104	4779101639223	4779101636918	4779101637984

# STYLE SL 250

## FRAMES



### 1-GANG FRAME

40 pcs. ABS

\*Article number \*\* EAN code (V) \*\*\* EAN code (D)



White



Ivory



Metallic



Champagne



Anthracite

* R01 ww	R01 iv	R01 mt	R01 ch	R01 an
** 4779101510058	4779101511055	4779101519358	4779101516364	4779101517392

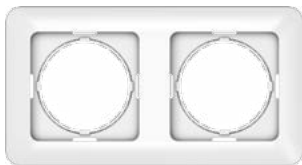

### 2-GANG FRAME

20 pcs. ABS

\*Article number \*\* EAN code (V) \*\*\* EAN code (D)



White



Ivory



Metallic



Champagne



Anthracite

* R02 ww	R02 iv	R02 mt	R02 ch	R02 an
** 4779101510065	4779101511062	4779101519365	4779101516371	4779101517408



### 3-GANG FRAME

15 pcs. ABS

\*Article number \*\* EAN code (V) \*\*\* EAN code (D)



White



Ivory



Metallic



Champagne



Anthracite

* R03 ww	R03 iv	R03 mt	R03 ch	R03 an
** 4779101510089	4779101511086	4779101519372	4779101516388	4779101517415



### 4-GANG FRAME

10 pcs. ABS

\*Article number \*\* EAN code (V) \*\*\* EAN code (D)



White



Ivory



Metallic



Champagne



Anthracite

* R04 ww	R04 iv	R04 mt	R04 ch	R04 an
** 4779101510096	4779101511093	4779101519389	4779101516395	4779101517422



### 5-GANG FRAME

10 pcs. ABS

\*Article number \*\* EAN code (V) \*\*\* EAN code (D)



White



Ivory



Metallic



Champagne



Anthracite



* R05 ww	R05 iv	R05 mt	R05 ch	R05 an
** 4779101510102	4779101511109	4779101519396	4779101516401	4779101517439

# STYLE SL 250

## ACCESSORIES



### MOUNTING PLATE FOR 1XRJ SOCKET WITH COVER PLATE, WITHOUT FRAME

 30 pcs.  ABS

\*Article number \*\* EAN code (V) \*\*\* EAN code (D)



White



Ivory



Metallic



Champagne



Anthracite

* KLRJ45-1 ww	KLRJ45-1 iv	KLRJ45-1 mt	KLRJ45-1 ch	KLRJ45-1 an
** 4779101700060	4779101701067	4779101819229	4779101816426	4779101817454



# STYLE PLUS SL+250



---

**STYLE PLUS SL+250** surface mounted series is a suitable solution for spaces where recessed assembly is not always possible. The compact design of this series will fit into various interiors where quick and simple light and power management is required.

# STYLE PLUS SL+250

## SWITCHES · TWO-WAY SWITCHES · PUSH-BUTTON SWITCHES “BELL”



### 1-GANG SWITCH

10 pcs. 10A, 250V~ IP20 ABS

\*Article number \*\* EAN code (V)

White Ivory Brown Anthracite

* P110-010 ww	P110-010 iv	P110-010 br	P110-010 an
** 4779101210118	4779101211115	4779101213133	4779101217070



### 2-GANG SWITCH

10 pcs. 10A, 250V~ IP20 ABS

\*Article number \*\* EAN code (V)

White Ivory Brown Anthracite

* P510-020 ww	P510-020 iv	P510-020 br	P510-020 an
** 4779101310078	4779101311075	4779101313079	4779101317022



### 1-GANG TWO-WAY SWITCH

10 pcs. 10A, 250V~ IP20 ABS

\*Article number \*\* EAN code (V)

White Ivory Brown Anthracite

* P610-010 ww	P610-010 iv	P610-010 br	P610-010 an
** 4779101410075	4779101411072	4779101413090	4779101417203



### 1-GANG PUSH-BUTTON SWITCH “BELL”

10 pcs. 10A, 250V~ IP20 ABS

\*Article number \*\* EAN code (V)

White Ivory Brown Anthracite

* P110-012 ww	P110-012 iv	P110-012 br	P110-012 an
** 4779101810035	4779101811032	4779101813036	4779101817065



### SOCKET OUTLET

10 pcs. 10A, 250V~ IP20 ABS

\*Article number \*\* EAN code (V)

White Ivory Brown Anthracite

* RP16-001 ww	RP16-001 iv	RP16-001 br	RP16-001 an
** 4779101110197	4779101111194	4779101113198	4779101117219

# STYLE PLUS SL+250

## SOCKET OUTLETS



### SOCKET OUTLET WITH SHUTTERS

10 pcs. ⚡ 10A, 250V~ IP20 ABS

\*Article number \*\* EAN code (V)

White Ivory Brown Anthracite

* RP16-001-20 ww	RP16-001-20 iv	RP16-001-20 br	RP16-001-20 an
** 4779101110333	4779101111330	4779101113365	4779101117356



### SCHUKO SOCKET OUTLET

10 pcs. ⚡ 16A, 250V~ IP20 ABS

\*Article number \*\* EAN code (V)

White Ivory Brown Anthracite

* RP16-002 ww	RP16-002 iv	RP16-002 br	RP16-002 an
** 4779101110203	4779101111200	4779101113204	4779101117226



### SCHUKO SOCKET OUTLET WITH SHUTTERS

10 pcs. ⚡ 16A, 250V~ IP20 ABS

\*Article number \*\* EAN code (V)

White Ivory Brown Anthracite

* RP16-002-20 ww	RP16-002-20 iv	RP16-002-20 br	RP16-002-20 an
** 4779101110340	4779101111347	4779101113372	4779101117363



### 2-GANG SOCKET OUTLET

6 pcs. ⚡ 16A, 250V~ IP20 ABS

\*Article number \*\* EAN code (V)

White Ivory Brown Anthracite

* RP16-020 ww	RP16-020 iv	RP16-020 br	RP16-020 an
** 4779101110210	4779101111217	4779101113211	4779101117233



### SCHUKO 2-GANG SOCKET OUTLET

6 pcs. ⚡ 16A, 250V~ IP20 ABS

\*Article number \*\* EAN code (V)

White Ivory Brown Anthracite

* RP16-021 ww	RP16-021 iv	RP16-021 br	RP16-021 an
** 4779101110371	4779101111378	4779101113228	4779101117240





# OTHER PRODUCTS

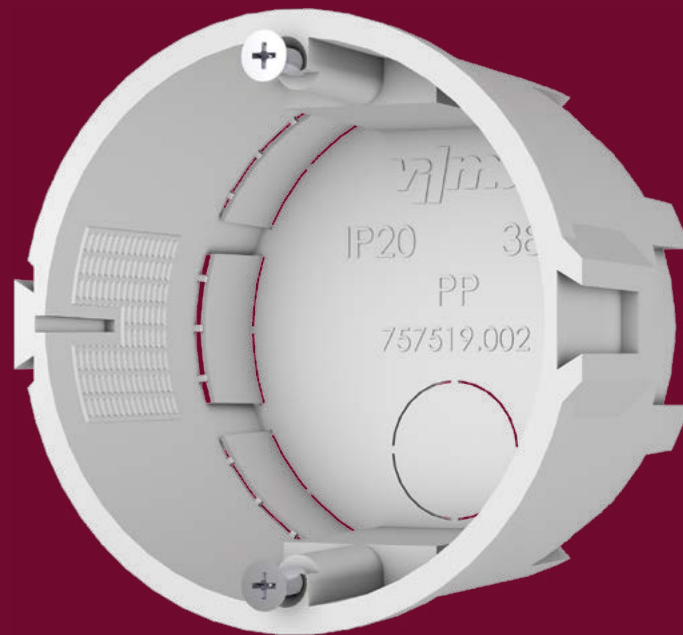

High quality and smooth performance of switches and plug sockets and other connection points is closely related to their installation. Reliable installation boxes and cable trunks will enable quick and easy installation of VILMA products.

# OTHER PRODUCTS



## FLUSH MOUNTING BOX (WITHOUT SCREWS)

 50 pcs.

\*Article number \*\* EAN code (V) \*\*\* EAN code (D)

 White

\* 757.519.001 ww

\*\* 4779101710199



## FLUSH MOUNTING BOX (CONNECTING, WITHOUT SCREWS)

 50 pcs.

\*Article number \*\* EAN code (V) \*\*\* EAN code (D)

 White

\* 757.519.002 ww

\*\* 4779101710205



## LID FOR FLUSH MOUNTING BOX

 100 pcs.

\*Article number \*\* EAN code (V) \*\*\* EAN code (D)

 White

\* 711.221.001 ww

\*\* 4779101710236

\*\*\* 4779101700237



## TV INSERT

 100 pcs.

\*Article number \*\* EAN code (V) \*\*\* EAN code (D)

 White

\* TVK ww

\*\* 4779101710120



## FLUSH MOUNTING BOX (WITH SCREWS)

 50 pcs.

\*Article number \*\* EAN code (V) \*\*\* EAN code (D)

 White

\* 757.519.001-01 ww

\*\* 4779101710212

# OTHER PRODUCTS



## FLUSH MOUNTING BOX (CONNECTING, WITH SCREWS)

 50 pcs.

\*Article number \*\* EAN code (V) \*\*\* EAN code (D)

 White

\* 757.519.002-01 ww

\*\* 4779101710229



## INTERMEDIATE

 300 pcs.

\*Article number \*\* EAN code (V) \*\*\* EAN code (D)

\* 741.131.002

\*\* 4779101708127



## ILLUMINATION LIGHTS KIT

 10 pcs.

\*Article number \*\* EAN code (V) \*\*\* EAN code (D)

\* PLK01

\*\* 4779101710113



## PVC CABLE TRUNK 17X15, 2M

 48 pcs.

\*Article number \*\* EAN code (V) \*\*\* EAN code (D)

 White

\* 17x15 ww

\*\* 4779101000498



## PVC CABLE TRUNK 25X15, 2M

 48 pcs.

\*Article number \*\* EAN code (V) \*\*\* EAN code (D)

 White

\* 25x15 ww

\*\* 4779101000467

# OTHER PRODUCTS



## PVC CABLE TRUNK 40X40, 2M

 12 pcs.

\*Article number \*\* EAN code (V) \*\*\* EAN code (D)

 White

\* 40x40 ww

\*\* 4779101000481



## PVC PIPE (CONNECTED) Ø16, 1.5M

 60 pcs.

\*Article number \*\* EAN code (V) \*\*\* EAN code (D)

 White

\* Ø16 ww

\*\* 4779101000504



## PVC PIPE (CONNECTED) Ø20, 1.5M

 40 pcs.

\*Article number \*\* EAN code (V) \*\*\* EAN code (D)

 White

\* Ø20 ww

\*\* 4779101000511



## PVC CABLE TRUNK 17X15 WITH STICKER, 2M

 24 pcs.

\*Article number \*\* EAN code (V) \*\*\* EAN code (D)

 White

\* 17X15T ww

\*\* 4779101000528



## PVC CABLE TRUNK 25X15 WITH STICKER, 2M

 48 pcs.

\*Article number \*\* EAN code (V) \*\*\* EAN code (D)

 White

\* 25X15T ww

\*\* 4779101000535

# OTHER PRODUCTS



## PVC CABLE TRUNK 35X15 WITH STICKER, 2M

 12 pcs.

\*Article number \*\* EAN code (V) \*\*\* EAN code (D)



White

\* 35X15T ww

\*\* 4779101000542



## FLEXIBLE PIPE CONNECTOR ZCLF 16

 100 pcs.

\*Article number \*\* EAN code (V) \*\*\* EAN code (D)



Grey

\* ZCLF16 gr

\*\* 8032636767103



## FLEXIBLE PIPE CONNECTOR ZCLF 20

 100 pcs.

\*Article number \*\* EAN code (V) \*\*\* EAN code (D)



Grey

\* ZCLF20 gr

\*\* 8032636767110



## FLEXIBLE PIPE CONNECTOR ZCLF 25

 100 pcs.

\*Article number \*\* EAN code (V) \*\*\* EAN code (D)



Grey

\* ZCLF25 gr

\*\* 8032636767127



## FLEXIBLE PIPE CONNECTOR ZCLF 32

 50 pcs.

\*Article number \*\* EAN code (V) \*\*\* EAN code (D)



Grey

\* ZCLF32 gr

\*\* 8032636767134

# OTHER PRODUCTS



## FLEXIBLE PIPE CONNECTOR ZCLF 40

 70 pcs.

\*Article number \*\* EAN code (V) \*\*\* EAN code (D)



Grey

\* ZCLF40 gr

\*\* 8032636767141



## FLEXIBLE PIPE CONNECTOR ZCLF 50

 40 pcs.

\*Article number \*\* EAN code (V) \*\*\* EAN code (D)



Grey

\* ZCLF50 gr

\*\* 8032636767158





# DIMENSIONS

## QUADRUM QR 1000

1-gang frame	90 x 85 mm	4-gang frame	303 x 85 mm
2-gang frame	161 x 85 mm	5-gang frame	374 x 85 mm
3-gang frame	232 x 85 mm		

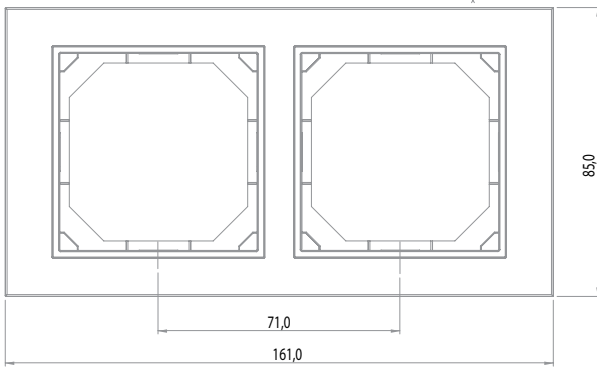
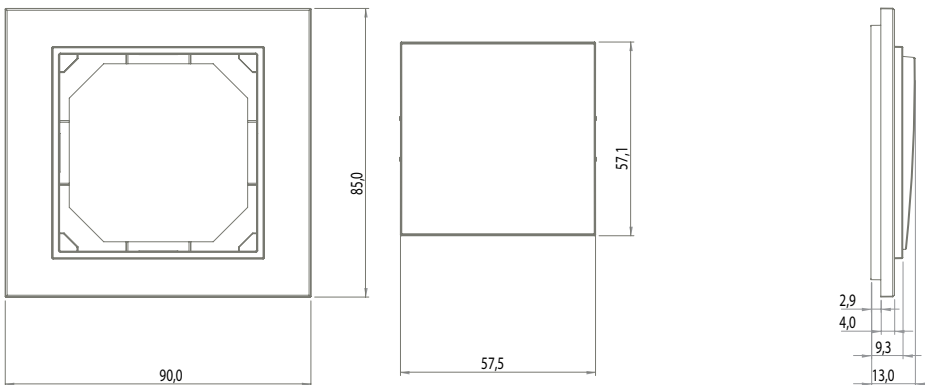

## EXPRESS XP 500

1-gang frame	103,0 x 81 mm	4-gang frame	316,2 x 81 mm	2-gang vertical frame	88,7 x 152,10 mm
2-gang frame	174,1 x 81 mm	5-gang frame	387,2 x 81 mm	3-gang vertical frame	88,7 x 223,15 mm
3-gang frame	245,2 x 81 mm				

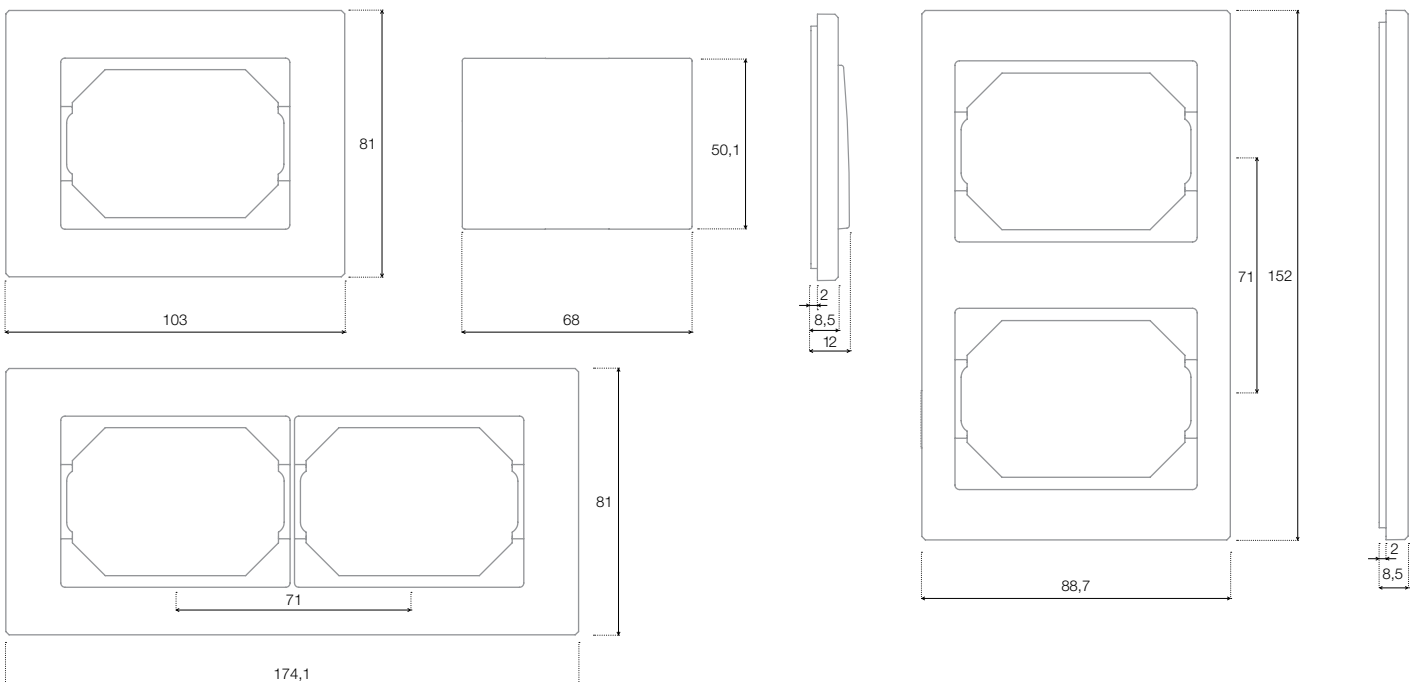

# DIMENSIONS

<b>LUXE LX 200</b>	1-gang frame	80,5 x 80,5 mm	4-gang frame	293,5 x 80,5 mm
	2-gang frame	151,6 x 80,5 mm	5-gang frame	364,5 x 80,5 mm
	3-gang frame	222,5 x 80,5 mm		

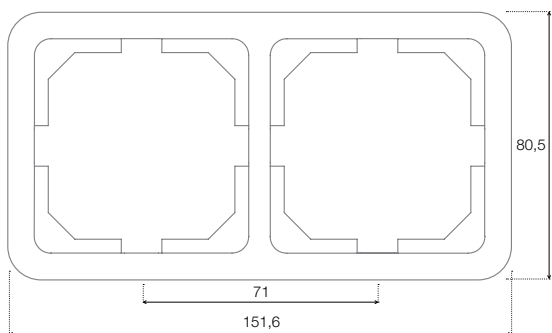
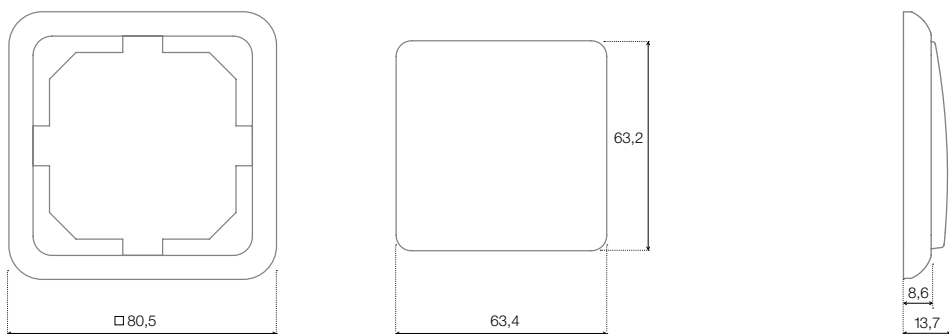

<b>SPECTRUM SP 300</b>	1-gang frame	80,5 x 80,5 mm	4-gang frame	293,5 x 80,5 mm
	2-gang frame	151,6 x 80,5 mm	5-gang frame	364,5 x 80,5 mm
	3-gang frame	222,5 x 80,5 mm		

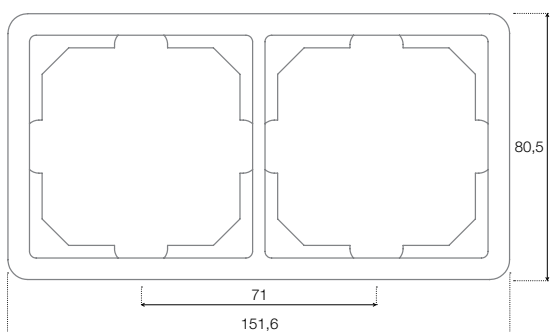
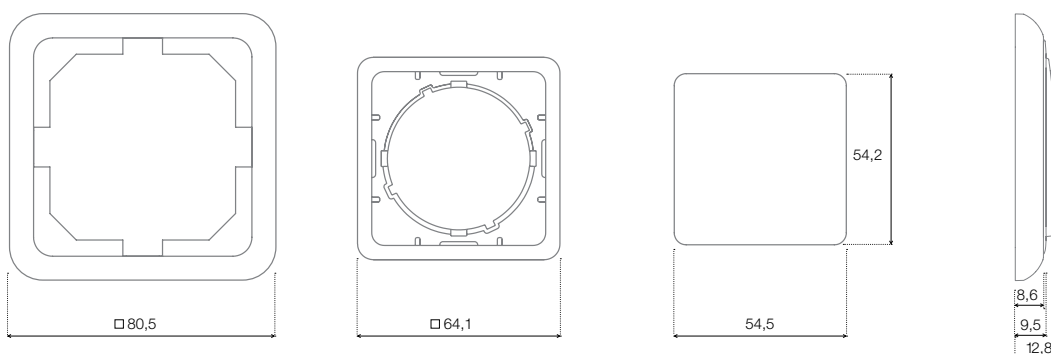

# DIMENSIONS

## STANDARD ST 150

1-gang frame 80,3 x 80,3 mm  
 2-gang frame 151,3 x 80,3 mm  
 3-gang frame 222,0 x 80,3 mm

4-gang frame 293,0 x 80,3 mm  
 5-gang frame 364,0 x 80,3 mm

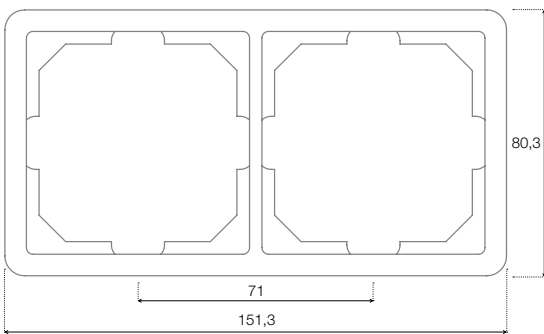
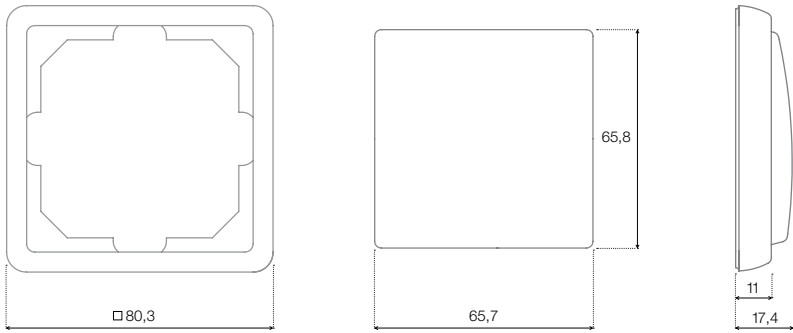

## STYLE SL 250

1-gang frame 81,0 x 81 mm  
 2-gang frame 152,0 x 81 mm  
 3-gang frame 223,0 x 81 mm

4-gang frame 294,0 x 81 mm  
 5-gang frame 365,2 x 81 mm

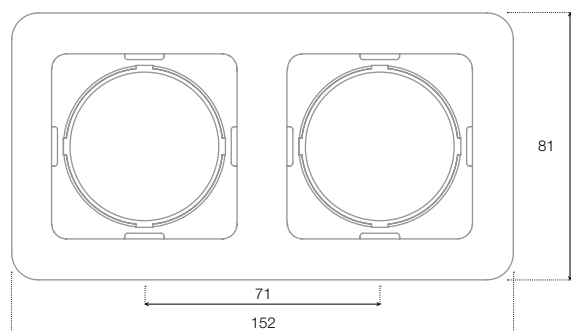
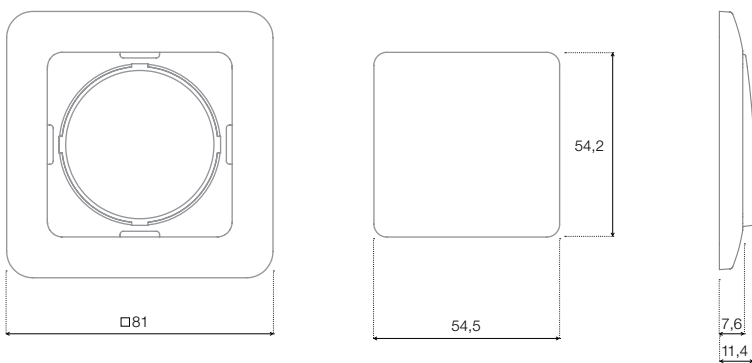

# DIMENSIONS

Surface-mounting

**STYLE PLUS SL+250**

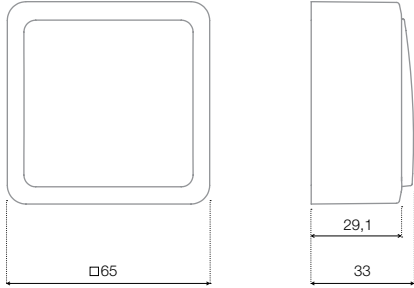

Surface-mounting

**STANDARD ST 150**

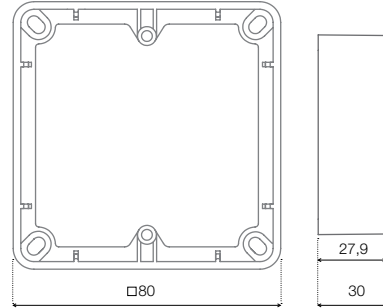

# DIAGRAMS

## WIRING DIAGRAMS FOR SWITCHES

L - "phase" wire    N - "neutral" wire

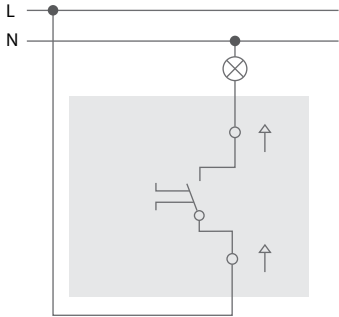

1-GANG SWITCH

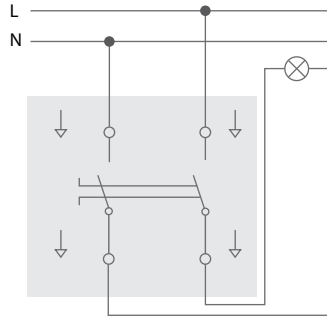

1-GANG 2 POLE SWITCH

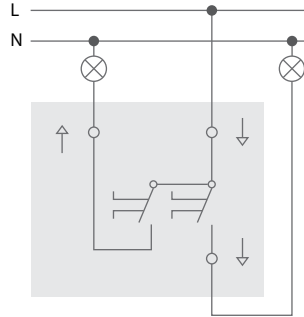

2-GANG SWITCH

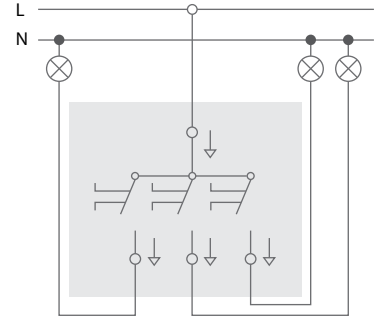

3-GANG SWITCH

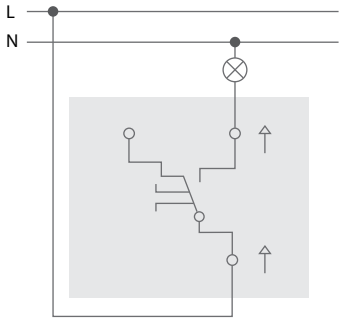

1-GANG TWO-WAY SWITCH

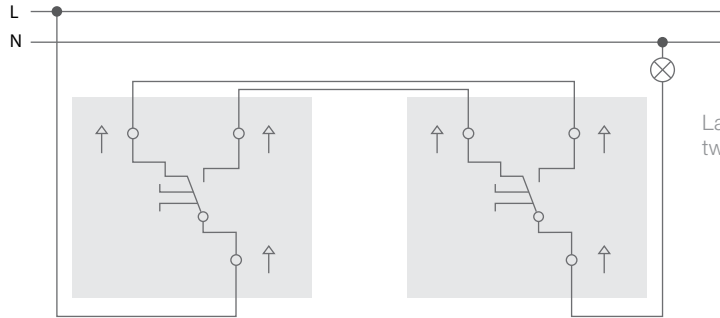

Lamp control with two step switches

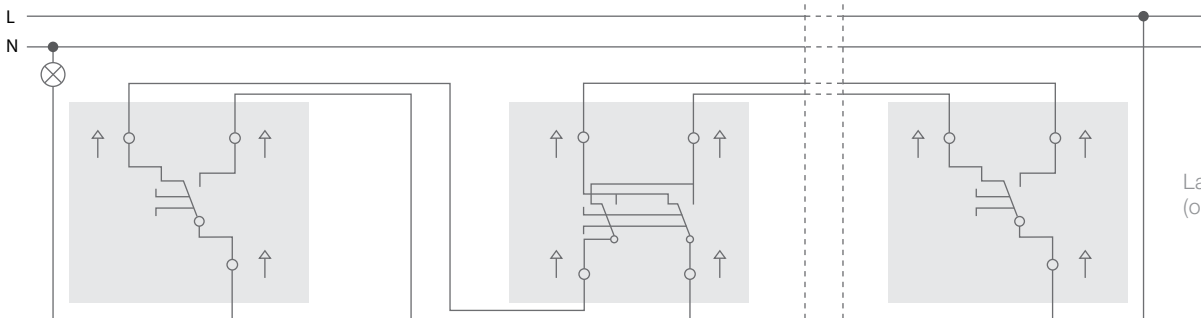

Lamp control with three (or more) switches

1-GANG TWO-WAY SWITCH

1-GANG INTERMEDIATE SWITCH

1-GANG TWO-WAY SWITCH

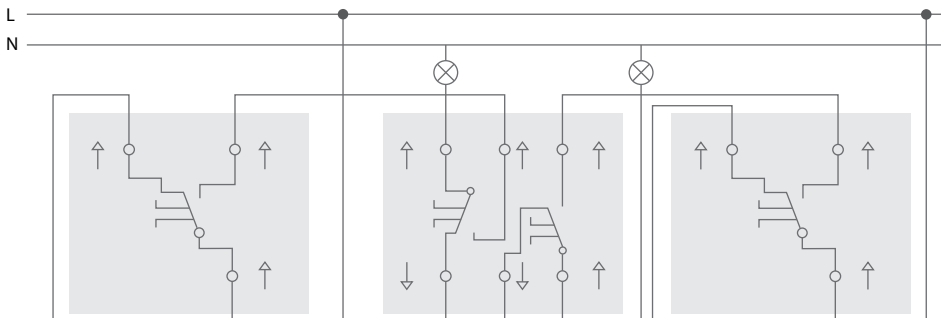

1-GANG TWO-WAY SWITCH

2-GANG TWO-WAY SWITCH

1-GANG TWO-WAY SWITCH

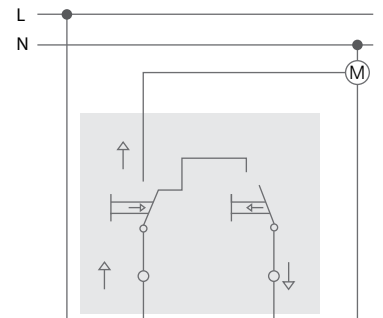

2-GANG BLIND SWITCH

2 lamps control with three step switches

# DIAGRAMS

## DIMMER FOR INCANDESCENT AND HALOGEN LAMPS

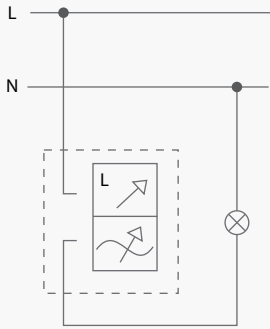

For incandescent, halogen and dimmable compact 220V lamps

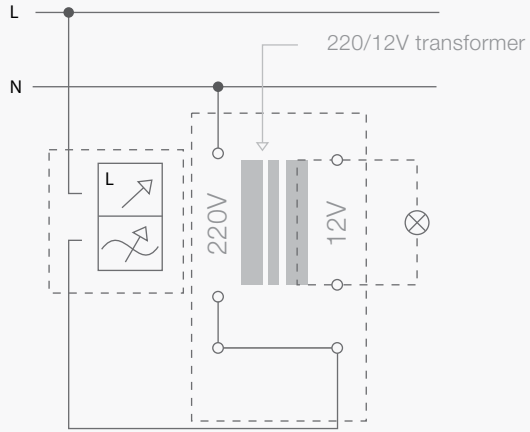

For halogen 12V lamps, connected via transformer

## DIMMER FOR LED DIMMABLE LAMPS

Single-circuit

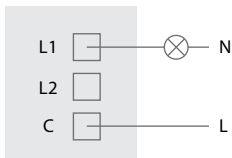

Two-way circuit

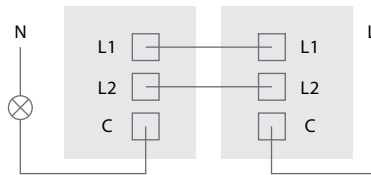

DIMMER

TWO-WAY SWITCH

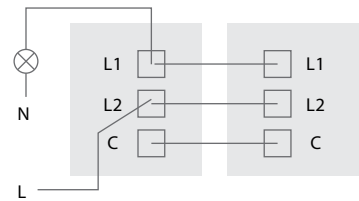

DIMMER

TWO-WAY SWITCH

## THERMOSTATS

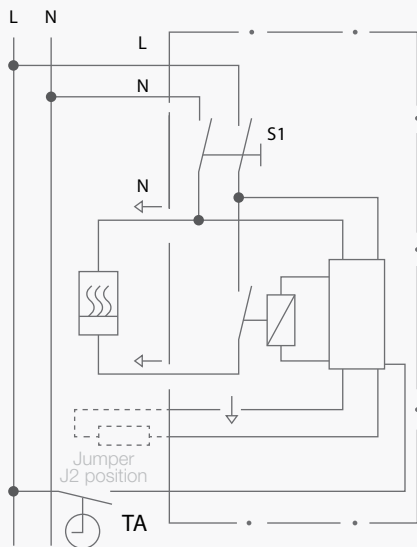

Room thermostat

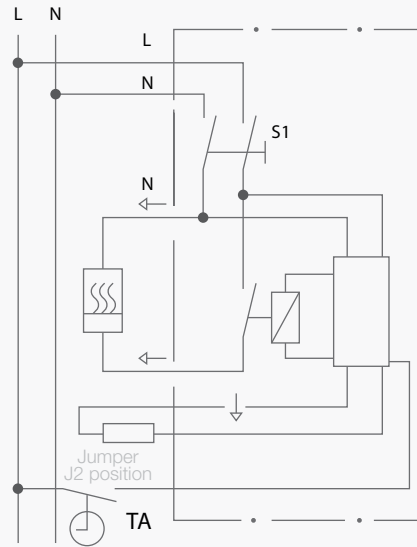

Floor thermostat

# DIAGRAMS

## TECHNICAL SPECIFICATION SHEET INTELLIGENT DIMMER DPI-01

DPI-01 dimmer switch is an intelligent programmable device, designed to regulate dimmable LED lighting, halogen lighting powered by an electronic transformer, incandescent lighting. The dimmer enables in a programmable way change of the minimum lighting setting and operating mode. You can change the operating mode only when the dimmer is working incorrectly, eg when the lighting is winking. The dimmer works in mode 2 by default.

The DPI-01 dimmer switch has overload and short-circuit protection. If an overload occurs, the dimmer switches off automatically.

### Change of the DPI-01 dimmer's minimum lighting setting:

Note: All programming activities should be performed smoothly one by one with a maximum of 3 seconds lag between each point. In case of the flickering effect of the light when it is darkened, the minimum brightness setting should be increased.

### Change the minimum lighting setting in accordance with the following points:

1. Turn on the dimmer and turn the knob to the MINIMUM position (turn the knob completely to the left).
2. Turn off the dimmer and run it again 3 times, leaving about a second between pressing: OFF - 1s - ON - 1s - OFF - 1s - ON - 1s - OFF - 1s - ON.
3. The light will start winking and then go off, which will mean, that the dimmer is in CONFIGURATION mode.
4. Within max 3 seconds from the moment when the light goes off turn the knob to the right until the lights turn on, then you can proceed to the minimum dimmer brightness selection, which you will be happy with. Leave the dimmer in this position. After 3 seconds, the dimmer will notice, that the minimum regulation has been set up. The light will shine once more brightly once less, which means, that the dimmer has returned to normal operation.

### Change of DPI-01 dimmer operation mode:

1. Turn on the dimmer and turn the knob to the MAXIMUM position (turn the knob completely to the right).
2. Turn off the dimmer and restart it 3 times, leaving about a second between pressing: OFF - 1s - ON - 1s - OFF - 1s - ON - 1s - OFF - 1s - ON - 1s.
3. The light winks a few times and then goes off, which will mean, that the dimmer is in CONFIGURATION mode.
4. To select MODE 1, turn the potentiometer to the MINIMUM position within 3 seconds and then back to the MAXIMUM position.
5. To select MODE 2, turn the potentiometer to the MINIMUM position within 3 seconds.
6. The amount of light brightness will indicate the mode in which the dimmer is currently working.
7. The device returns to normal operation.

**Connection and assembly method** Typical 1-way circuit connecting diagram 2-ways circuit connecting diagram.

Typical 1-way circuit connecting diagram

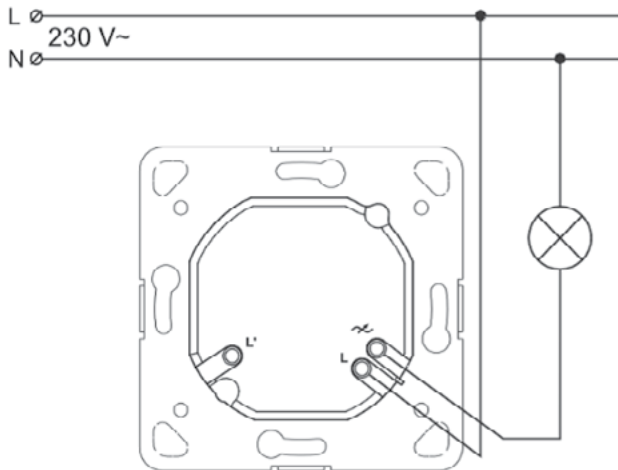

2-ways circuit connecting diagram

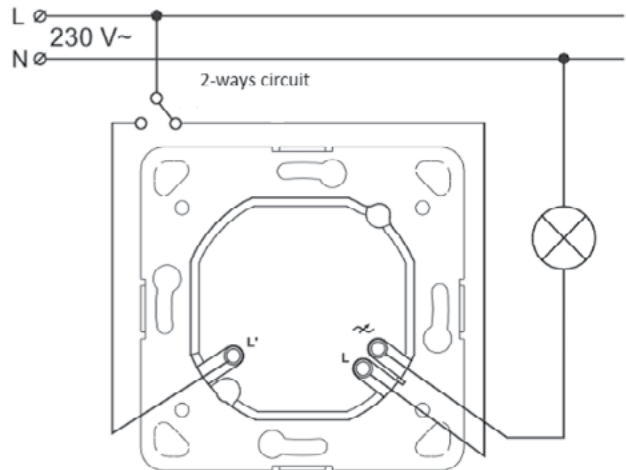

### Basic parameters:

- Rated supply voltage: 230 VAC
- Supply voltage tolerance: -15 +10%
- Rated frequency: 50 Hz
- Lighting control: switch and adjustment on the potentiometer
- LED load power: 0 ÷ 100W, but max 10 dimmable LED bulbs
- The power of incandescent and halogen load: 10 ÷ 250W
- Note: DPI-01 dimmer does not work with a halogen load supplied by a magnetic transformer (eg a toroidal transformer)
- Weight: 0,120kg
- Number of connection terminals: 3
- Cross-section of connection cables: max 1mm<sup>2</sup>
- Mounting the casing: standard wall junction box Ø60 mm
- Protection degree: IP20
- Temperature range of work: from -20 °C to +45 °C
- Pollution degree: 2
- Dimensions: 70 x 70 x 31 mm
- Weight: 0,120 kg

# DIAGRAMS

## WIRING DIAGRAMS FOR TV SOCKETS





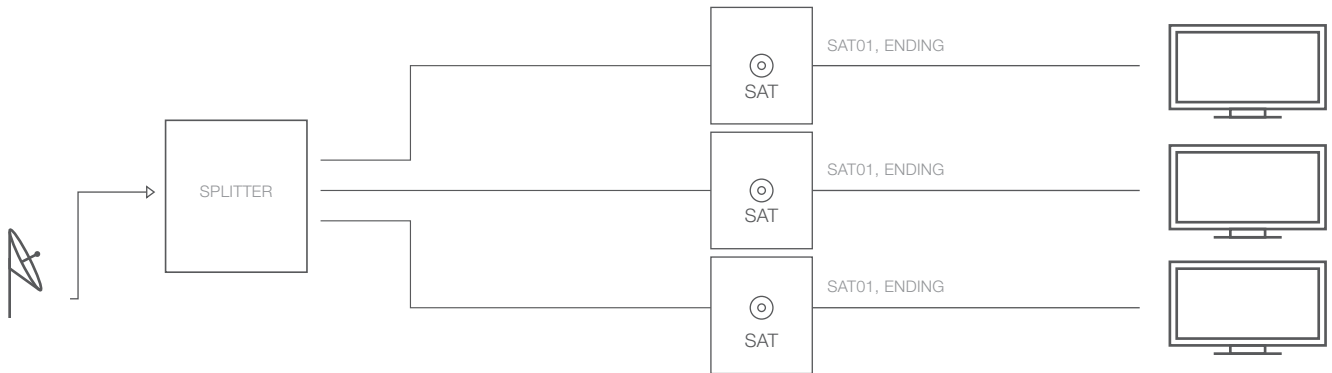



The number of television sets that can be connected depends on the type of splitter chosen



The number of television sets that can be connected depends on the type of splitter chosen



## CONVENTIONAL SYMBOLS

	Number of items in a box		Product surface material: PC – polycarbonate, ABS – Acrylonitrile Butadiene Styrene
	Voltage, current, or frequency		Production by the order – orders are processed within 15 working days
	Product protection class		EXPRESS XP 500 items, marked with an asterisk, have a different mode of illumination – light emits from a small bulb in the key. In all other products, the light emanates from the gap between the key and the frame.

EAN code: the letters V and D denote differently packaged products. V (single unit) means the product is in the standard hanging package, suited for shopping centres or supermarkets. D (wholesale) means the product is placed in a separate bag. The number of frames in wholesale packages is coordinated separately, and packaging may vary.

**AB VILMA**

[www.vilmaelectric.com](http://www.vilmaelectric.com)



Zirmunu g. 68, LT-09124 Vilnius

Tel. +370 5 247 2348

E-mail [sales@vilma.lt](mailto:sales@vilma.lt)

***vilma***